

SOUND DEVICES



A20-Nexus Go

4-, 6-, and 8-Channel, True-Diversity Receiver
with SpectraBand Technology

User Guide v1.53

Table of Contents

Welcome to the A20-Nexus Go	3
Key Features	3
SpectraBand	4
Digital Wireless Modulation	4
NexLink Wireless Transmitter Control	4
GainForward	4
Architectural Overview	6
Panel Views	7
Typical Setup	10
Quick Start	11
Powering	14
Navigating the A20-Nexus Go User Interface	15
RX Views	17
Menus	26
RTSA (Real Time Spectrum Analyzer)	27
Scan Mode	30
AutoAssign	30
TX List	32
RF Menu	34
Antenna RF Overload Indication	35
Audio Outputs	36
Timecode	38
System Menu	39
Quick Setup Menu	42
Updating Firmware	44
Channel Expansion Licenses	44
Accessories	45
A20-QuickDock for 8-Series	45
A20-Monarch Antenna	50
A20-Shelf	50
A20-2.4G Ant+Mount	50
NexLink Status Alerts	52
Frequency Band Restrictions	53
Connector Pin Assignments	54
A20-Nexus Go Specifications	56
A20-Monarch Specifications	58
Note on RF Interference	59
Servicing the A20-Nexus Go	59
Warranty	59
Legal Notices	60
Declaration of Conformity	63

Welcome to the A20-Nexus Go

The A20-Nexus Go is an ultra-high performance, multichannel wireless microphone receiver in a compact ½-rack wide chassis. It features 4 independent, true-diversity channels that can be expanded to 6 or 8 true-diversity channels via software license. The A20-Nexus Go features NexLink, an innovative concept in wireless microphone receivers: full remote control of microphone transmitters via an integrated, long-distance RF link.

The A20-Nexus Go is ideal for use in a portable bag setup or mounted in a standard 19-inch rack. Additionally, the A20-Nexus Go can be docked to Sound Devices 833, 888, or Scorpio mixer-recorders using the A20-QuickDock accessory, which provides convenient power, audio, and timecode connections with no additional cables. This accessory allows the A20-Nexus Go to connect and disconnect from the 833, 888, or Scorpio in seconds with no tools.

Key Features

- 4-channel ultra-high-performance, true-diversity receivers in a ½ rack size (8.0" x 6.6" x 1.6").
- Expandable to 6 or 8 channels via 2-channel expansion licenses.
- 169 MHz – 1525 MHz tuning range via SpectraBand Technology.
- NexLink: integrated, long-distance remote control of all wireless transmitters, including group power on/off.
- Integrated Real Time Spectrum Analyzer (RTSA) and scanning for intuitive frequency coordination.
- AutoAssign: automatic deployment of clean frequencies in seconds.
- Flexible powering: via DC input, 8-Series, or AC mains (with optional adapter).
- DB-25 connector for 8 channels of mic, line, or AES outputs.
- Wide, 6.2" color OLED array with touch for control and monitoring.
- A20-QuickDock allows docking and undocking in seconds from 8-Series mixer-recorders with no tools.
- Supports GainForward Architecture: No gain setting on the A20 transmitter. Adjust gain at the receiver or mixer.
- 100% digital long-range modulation delivers the longest transmission distance of any digital system on the market.
- RF SAW filters for excellent rejection of interference from nearby IFB or camera hop transmitters.
- Excellent audio quality, full 10 Hz – 20 kHz audio bandwidth.
- BNC timecode input for auto timecode sync of transmitters over NexLink.
- Front panel and rear panel BNC antenna inputs. Compatible with passive and bias-powered antennas.
- Supports control of the Wisycom LFA smart antenna.
- Cascade out option on rear BNCs for cascading multiple A20-Nexus Go units.
- USB-A port for thumb drives, keyboards, transmitter pairing, and timecode syncing. Supports USB hubs.

Our friendly and knowledgeable support team, based in the USA and the UK, is here for all your questions and comments.

SpectraBand

The A20-Nexus Go incorporates SpectraBand, a technology that enables the A20-Nexus Go to tune over a super wide range of 169-1525 MHz. Tuning within this range varies by country.

For instance:

In the USA, the available frequency ranges are:

- The VHF band (169-216 MHz)
- The entire UHF TV band (470-608 MHz)
- The 600 MHz guard band (614-616 MHz)
- The 600 MHz duplex gap (653-663 MHz)
- The 900 MHz ISM band (902-928MHz)
- The 950 MHz STL band (941.5-960 MHz)
- The 1.5 GHz AFTRCC band (1435-1525 MHz), with an appropriate license.

In the UK, the available frequency ranges are:

- The VHF band (173-210 MHz)
- The core UK UHF TV band (470-702 MHz)
- The 800 MHz duplex gap (823-832 MHz)
- The 800 MHz guard band (863-865 MHz)
- The DME bands (961-1015 MHz, 1045-1075 MHz, 1105-1154 MHz), with an appropriate license
- The IMT band (1518-1525 MHz)

Please see <https://www.sounddevices.com/available-frequencies/> for further detailed information on which frequency ranges are available for each country.

Tuning Bands

SpectraBand's 169-1525 MHz range is divided into multiple, tightly-filtered tuning bands. The sharp attenuation at either end of a tuning band's range significantly reduces out-of-band interference resulting in excellent range performance.

Digital Wireless Modulation

Long Range and Standard Modulation

The A20 wireless products offer two proprietary digital modulation schemes that provide unbeatable range, unrivaled audio quality, and very low latency. Long Range or Standard modulation can be selected on a per-receiver-channel basis. Long Range modulation has better sensitivity which results in better range. The modulation setting must match among the A20 transmitters, A10-TX transmitter and the A20-Nexus Go in order for the transmitted signal to be received and decoded.

Intermodulation Immunity

Because the A20 and A10 digital RF transmission is inherently resistant to intermodulation, multiple A10 and A20 Digital Wireless systems can be used simultaneously on nearby adjacent frequencies without significant worry of intermodulation interference. Systems can be used together when separated by at least 400 kHz. When operating in the 902-928 MHz Band, it is recommended to separate channel frequencies by at least 1 MHz.

NexLink Wireless Transmitter Control

NexLink is a proprietary 2.4 GHz bidirectional wireless data link technology that allows multiple A20 transmitters to be controlled, monitored, and timecode synced from an A20-Nexus Go over long distances. NexLink is designed to offer robust and reliable control over distances far exceeding that of the wireless audio transmission, even in the presence of Wi-Fi and Bluetooth interference. An A20-Nexus Go can pair with up to 64 NexLinked transmitters.

GainForward

The A20-Nexus Go supports the A20 transmitter's GainForward feature. GainForward eliminates the need to adjust microphone preamplifier gain at the wireless transmitter. Audio levels from the transmitter are controlled either directly from the 8-Series (or any other mixer) trim controls, or from the A20-Nexus Go receiver screen. If the talent speaks too softly or emotes too loudly after being

“wired” with the transmitter, simply adjust the transmitter gain with the mixer’s gain trim, instead of having to access the actual transmitter. Read more about GainForward at: <https://www.sounddevices.com/gainforward-explained/>

When an A20-Nexus Go receiver channel is receiving signal from an A20 transmitter, adjust the receiver channel’s gain, low cut, and polarity from its associated [1RX view](#).

When the A20-Nexus Go is docked on an 8-Series, the Nexus receiver’s gain, low cut, and polarity settings are bypassed and hidden. In this case, adjust the 8-Series’ trim, low cut and polarity gain as necessary. See the 8-Series User Guides for more information.

Architectural Overview

The A20-Nexus Go takes a brand new approach to professional audio receiver design. The A20-Nexus Go combines several technologies, resulting in a very powerful and versatile product. The diagram below illustrates the architecture of the A20-Nexus Go.

The first thing to note about the architecture is that there are two entire signal paths. This performs the True Diversity reception inherent in the design. This is a lavish proposition, as it doubles the circuitry, but it is absolutely the best way to perform spatial diversity - superior to any type of antenna or phase diversity.

The first section that comes right after the receive antennas is the first SAW filter array. This pre-select filter is a key element of our unique SpectraBand technology. It allows for a tuning range from 169 MHz - 1525 MHz that is divided into multiple, tightly-filtered tuning bands. The extremely sharp attenuation at either end of a tuning band's range significantly reduces unwanted interference outside the selected tuning band, resulting in excellent range performance. Tuning bands vary in width, but tend to be around 24 MHz wide.

Next is the Low-Noise Amplifier (LNA), which is one of the most important stages in the design. This section has been specially designed for very low noise and high dynamic range, which results in long-range reception and high overload capability. This LNA stage exhibits a noise figure of only 0.35 dB, one of the very best on the market currently.

This is followed by yet another SAW filter array. This array further attenuates out-of-band signals, ensuring reliable reception, and greatly suppressing any image frequencies.

The Local Oscillator and Mixer perform the traditional function of a single downconversion superheterodyne radio. This section has been meticulously designed and is the other key element of our unique SpectraBand technology. This section exhibits extremely low phase noise and wide dynamic range to accurately downconvert the RF to a lower Intermediate Frequency (IF) for conversion into the digital domain.

Before conversion into the digital domain, the signal passes through its final array of SAW filters, rejecting any extraneous energy not wanted in the downconversion, as well as providing anti-aliasing before the Analog-to-Digital (A/D) converter. The A/D converter is a wideband, extremely high dynamic range part that accurately captures 24 MHz of IF energy into a digital version of that signal.

The real magic of the entire A20-Nexus Go happens within the Field-Programmable Gate Array (FPGA). An FPGA is essentially a giant custom, massively parallel processor programmed in house. The FPGA can perform filtering, frequency conversion, and demodulation in the digital domain that far exceeds anything that can be done via analog or traditional digital circuitry. The FPGA can perform demodulation of 16 channels simultaneously. The FPGA also performs the True Diversity operation that not only selects the best digital word from the two antennas but actually works at the bit level for additional range. The resultant audio signals are then fed out of the FPGA to the various audio outputs.

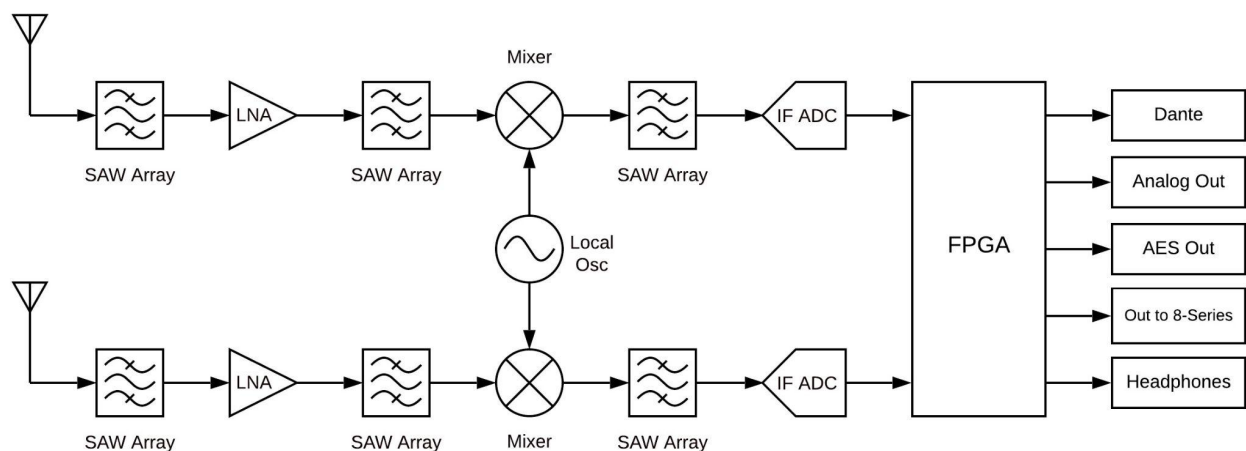

Panel Views

Front Panel

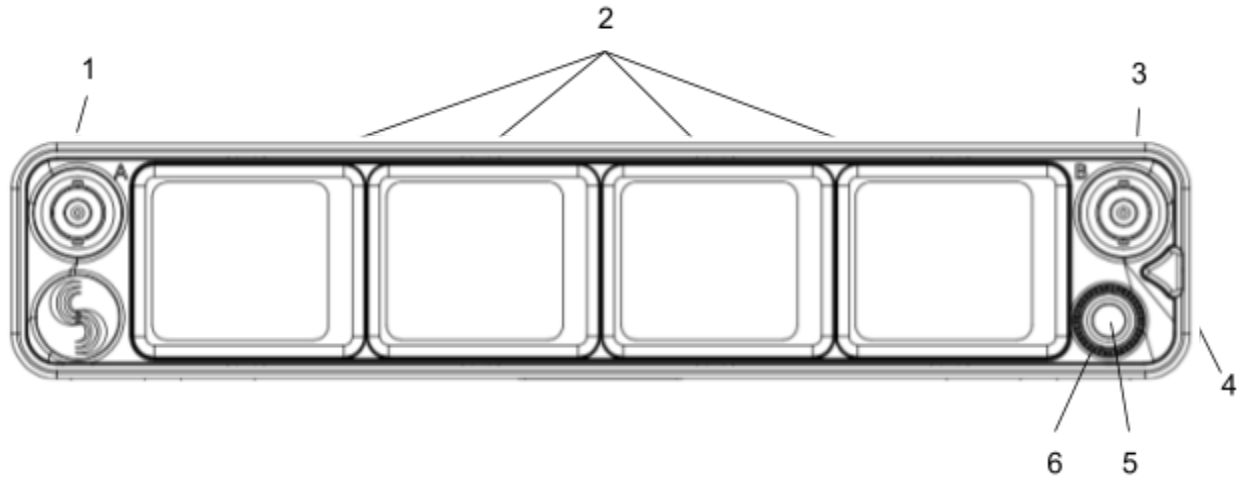

1 & 3: Antenna Connector A & B

BNC connectors, for connecting to active, passive, or smart antennas.

2: Touchscreens

Color OLED array for control and monitoring.

- Touch can be disabled to prevent inadvertent switching of the screens to different views. Press and hold the Headphone Knob for > 2 secs to disable. Re-enable by pressing and holding the Headphone Knob for > 2 secs. Disabled touch is indicated by a thin orange border around the four OLEDs. The Headphone Knob and Triangle button remain active when touch is disabled.
- Screensaver: To prevent burn in, the OLEDs can be set to turn off after a period of inactivity from the *Main Menu>System>Screensaver* setting.
- Lockout Mode: The whole front panel interface (OLEDs, Headphone Knob, and Triangle button) can be disabled to prevent unauthorized users from accessing settings. See *Main Menu>System>Lockout Mode*.

4: Triangle Button

- Press to power up. Press and hold to power down.
- When powered up, press to cycle through the current Receiver view, Main Menu, and RTSA. Backs out of sub-menus.

5: Control Knob

- Rotate to scroll through lists and select parameter values.
- Rotate to scroll frequency cursor or adjust horizontal/vertical zoom in RTSA/Scan view.

6: Multicolor Ring LED

- Solid blue when powering up
- Flashing orange when selected Sync Reference is not detected.
- Solid green when the front panel is locked out. See menu (*Main Menu>System>Lockout Mode*).

Rear Panel

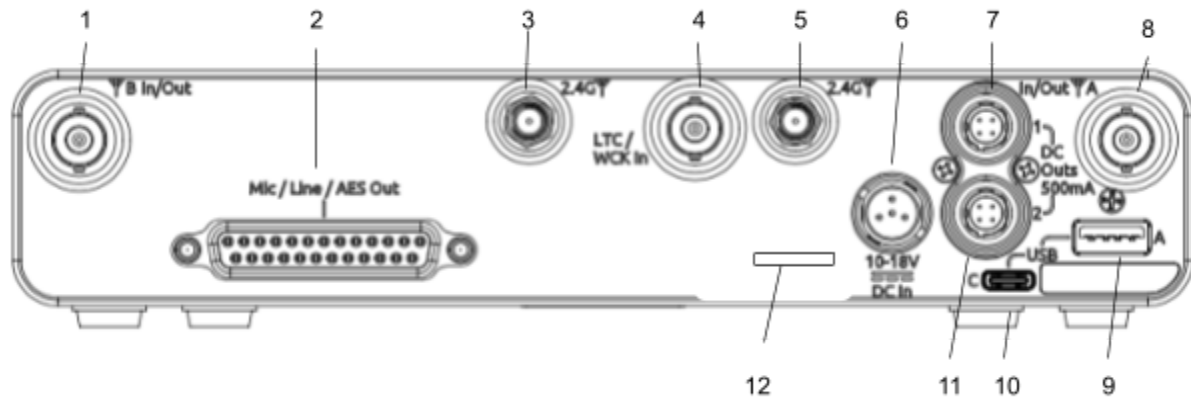

1 & 8: Antenna Connector A & B Inputs / Cascade Outs

- BNC connectors for connecting active, passive, or smart antennas.
- Cascade outs for looping through the front panel antenna A & B inputs. Only available when front panel antennas are selected in the (*Main Menu>RF*) menu. The cascade out passively splits the incoming signal, resulting in approximately 3.5 dB of loss. In some situations, additional antenna gain and/or amplification may be desirable to maintain excellent range.

2: D-Sub Audio Output Connector

25-pin D-Sub connector for outputting analog (mic/line/guitar level) or AES digital. See menu (*Main Menu>Audio Output*). Disabled when mounted to an 8-Series via the expansion port. Note: the pin-out follows the AES59 standard. The analog output pin-out is different from the AES digital output pin-out. See [Connector Pin Assignments](#) section for more information.

3 & 5: 2.4 GHz Antenna Connectors

Dual SMA-F ports for connecting 2.4 GHz SMA-M antennas for NexLink. Both antennas need to be connected.

Important: Only use the 2.4 GHz SMA-M antennas supplied with the A20-Nexus Go or equivalent. Do not use 2.4 GHz RP-SMA antennas such as those used for the 8-Series bluetooth antenna.

4: LTC / Word Clock Input

BNC for connecting LTC or Word Clock input. Nexus auto-detects whether the signal is LTC or Word Clock, including the associated frame rate or sample rate. Disabled when mounted to an 8-Series via the expansion port.

6: DC Input

TA4-M, 10-18V DC input. Disabled when docked to an 8-Series via the expansion port.

7 & 11: DC Outputs

Dual, 4-pin Hirose female DC outputs (500 mA max between both outputs) for powering IFB transmitters, camera hops, and other low-power peripherals. Disabled when docked to an 8-Series via the expansion port.

When powered via TA4, voltage is passed through from the DC input (10-18V).

9: USB-A Port

Multifunction USB-A port for:

- Pairing and syncing timecode to A20 transmitters. Connect the transmitter to A20-Nexus Go using a USB-C to USB-A cable.
- Connecting a USB keyboard for naming channels, quick setup files, and network. The USB keyboard is active whenever the virtual keyboard screen is displayed.
- Mounting a USB thumb drive for updating firmware and loading/saving settings.

Tip: The USB-A port supports USB hubs so that multiple devices can be connected at the same time. Maximum power output of 2.5 Watts (5V, 500 mA)

10: USB-C Port

For factory use only.

12: Card Slot

For factory-use only.

Bottom Panel

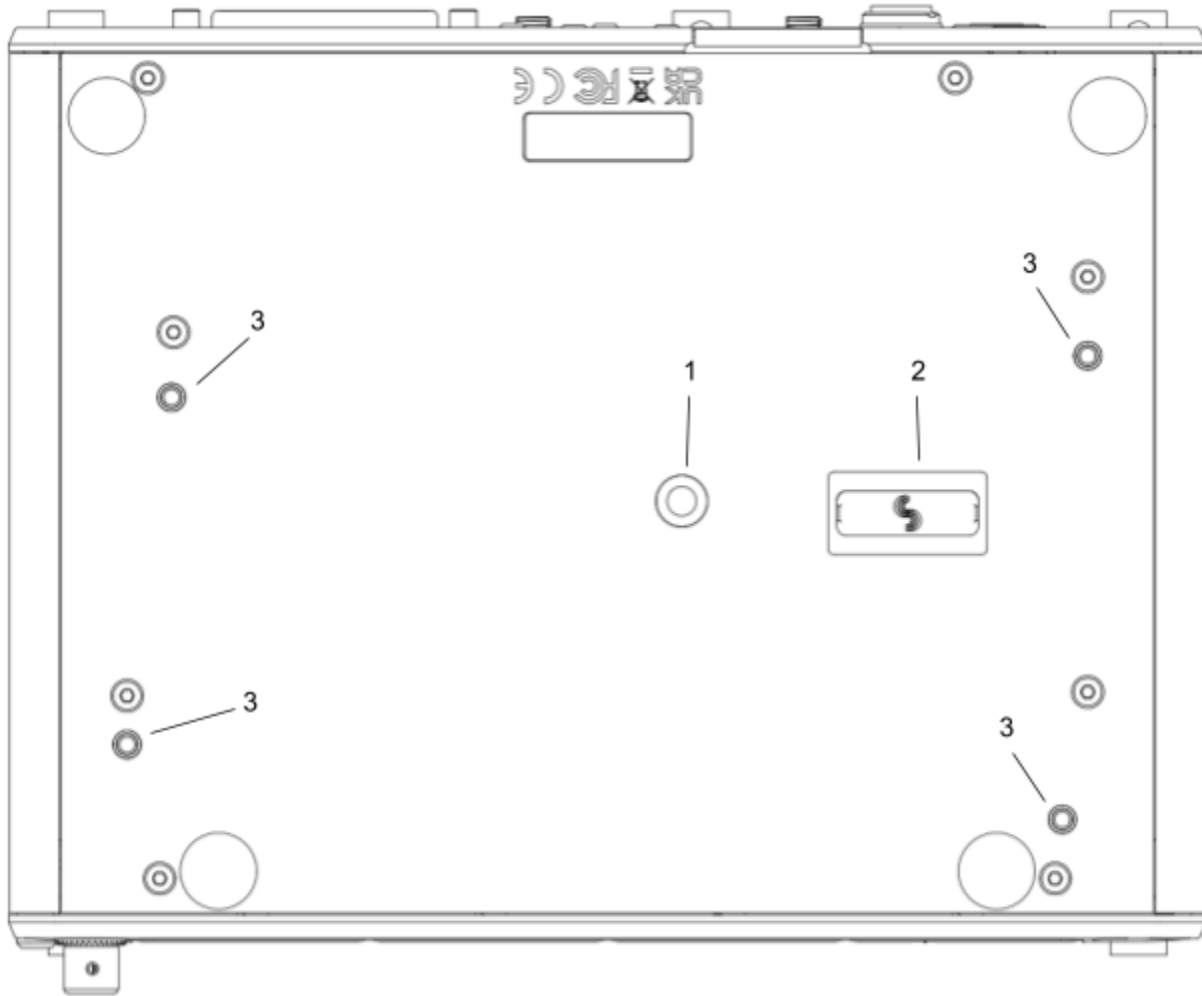

1: Mounting Point

1 / 4"-20 screw hole for mounting purposes.

2: Expansion Port

For docking A20-Nexus Go to an 8-Series mixer-recorder using the A20-QuickDock optional accessory.

The expansion port provides power from the 8-Series and passes the multichannel receiver's digital audio signals from A20-Nexus Go to the 8-Series. When docked on an 8-Series:

- The A20-Nexus Go and its NexLinked transmitters are controlled from the Nexus OLED touchscreen user interface. The 8-Series interface is not used for control.
- A20-Nexus Go rear panel connectors are disabled apart from the antenna connectors and the USB-A port.
- The USB-A port has the following capabilities:
 - Pairing A20 transmitters to the A20-Nexus Go by connecting a USB-C cable from the transmitter to the USB-A port.
 - Attaching a USB keyboard for entering text directly (e.g. receiver channel names) into the A20-Nexus Go.
 - Mounting a USB thumb drive for updating A20-Nexus Go firmware and saving setup files.
 - Syncing 8-Series timecode to an A20 transmitter from the A20-Nexus Go.

3: Screw holes for A20-QuickDock and A20-Shelf

Four screw holes for mounting the A20-Nexus Go to an A20-Shelf and A20-QuickDock

Typical Setup

The versatile A20-Nexus Go can be used in many types of setups and workflows. Here is an example with a 6-ch A20-Nexus Go (one expansion license installed) docked to an 8-Series mixer-recorder. The A20-QuickDock accessory enables the A20-Nexus Go to be docked to an 8-Series mixer-recorder. The bottom panel incorporates a multi-pin expansion port that connects power from the 8-Series and passes the multichannel receiver digital audio from A20-Nexus Go to the 8-Series.

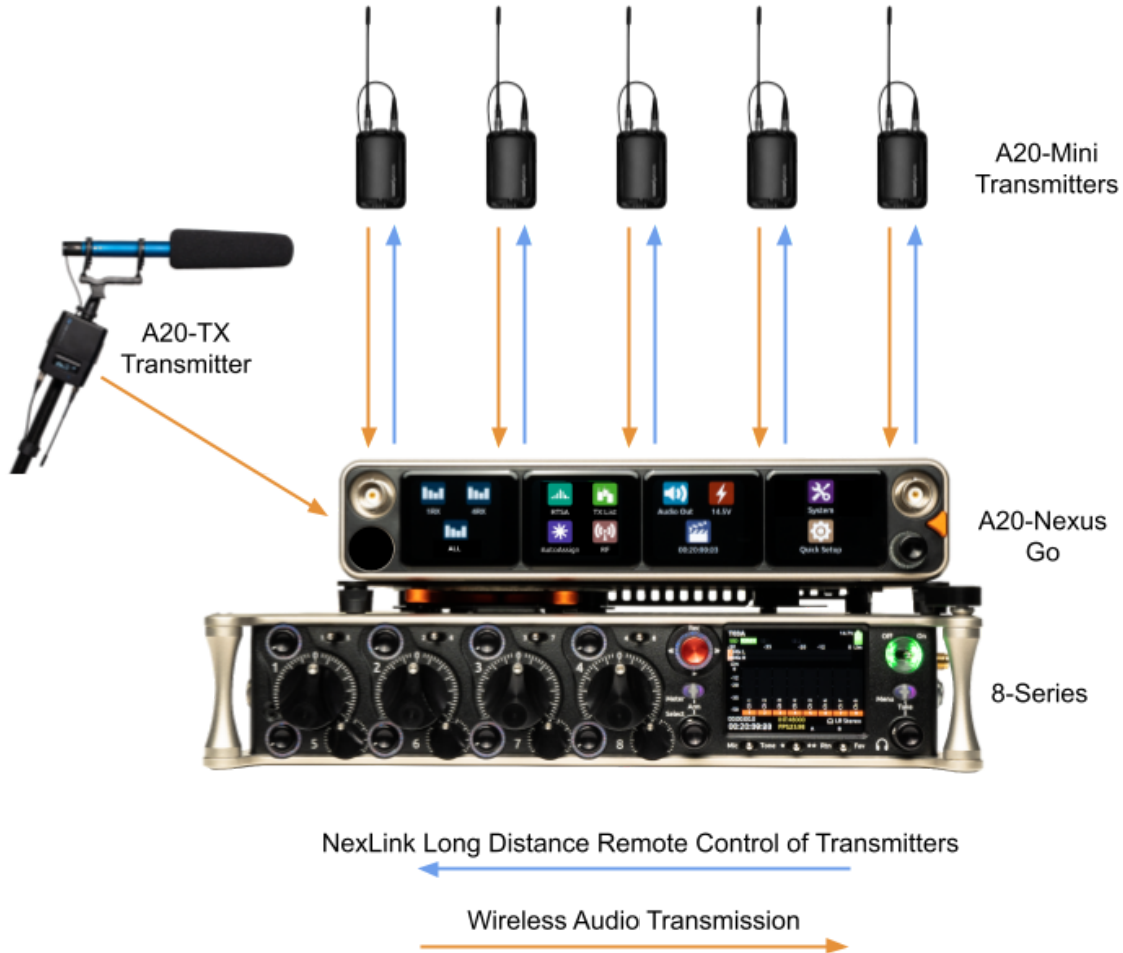

Quick Start

This Quick Start guide assumes that the A20-Nexus Go is being used as a standalone receiver.

1. Connect a 10-18V DC power source to the TA4-M DC input.
2. Connect suitable passive, bias-powered, or smart antennas to either the front or rear BNC A and B antenna ports.
3. If using NexLink to control and monitor A20 transmitters, connect 2.4 GHz antennas to both rear panel 2.4 GHz SMA ports.
4. Connect required rear panel audio outputs (Analog, AES) from the A20-Nexus Go to external devices.
5. **Power Up.** Press the front panel triangle button to power up. Press and hold to power down. When powered up for the very first time, receiver channels 1-4 are displayed. This view is called the ALL View (or 4RX View when expansion licenses are installed). All RX channels default to Off.

ALL View

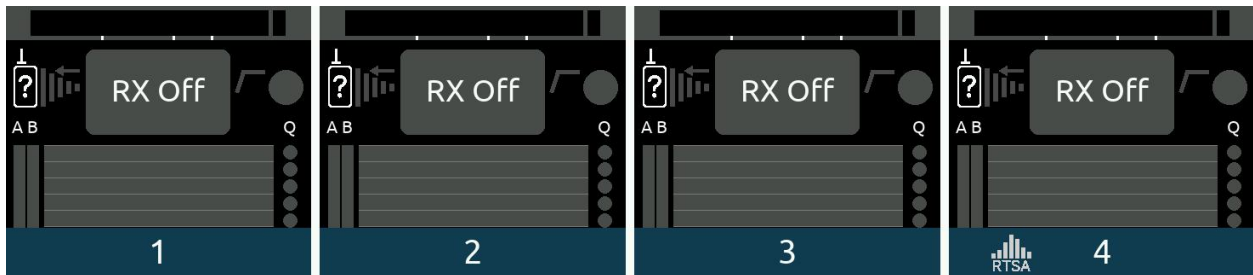

6. Press the triangle button to display the Main Menu.
7. Tap the System icon to enter the System menu.
8. Ensure Country is set to the country that you are in. The Country setting determines which Tuning Bands and RF frequencies are legally unrestricted and available for selection in the A20-Nexus Go. If using A20 transmitters, make sure that the A20-Remote app they are paired to is also set to the same country.

Main Menu



9. Tap the RF icon in screen 2 to access the RF menu.
10. Select Front or Rear antennas by tapping the button at the bottom of screen 2. When 'Rear' is displayed, the rear antennas are selected. When 'Front' is displayed, the front antennas are selected.

RF Menu

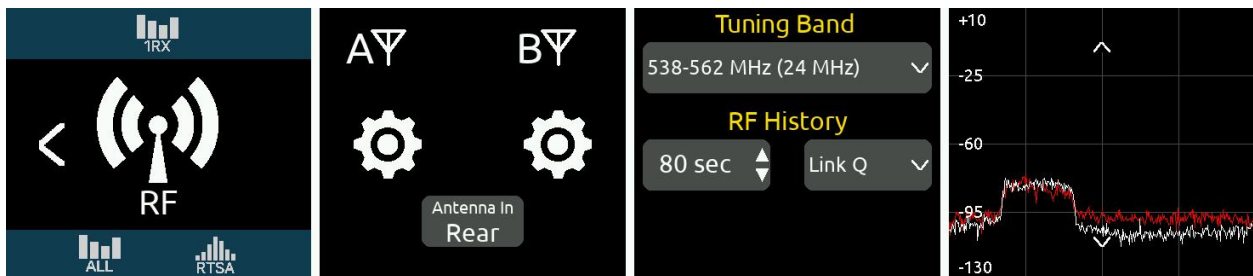

11. If the antennas require bias-power, tap the A and B antenna gear icons to display A and B antenna settings respectively and set both their Power (Bias) settings to On.

Antenna Settings



The antenna icons will show a lightning bolt icon next to them when bias power is enabled.



12. **Pair and NexLink A20 transmitters.** Pairing is a process that adds A20 transmitters to the A20-Nexus Go TX List. The TX List is an inventory of available transmitters that can be selected for wireless remote-control (via NexLink) and assigned to receiver channels.

Note: A10-TX transmitters cannot be paired or NexLinked with the A20-Nexus Go.

From the Main Menu, tap the TX List icon.



To pair an A20 transmitter, ensure it has a charged battery or batteries installed, then connect its USB-C port to the A20-Nexus Go USB-A port. The A20 transmitter will appear on the TX List after a few seconds. The A20-Nexus Go will then automatically establish a NexLink connection between the transmitter and the next available receiver channel. This can take up to a minute or so. Once connection is established, the NexLink RSSI icon is displayed in the TX List > NexLink column.

TX List

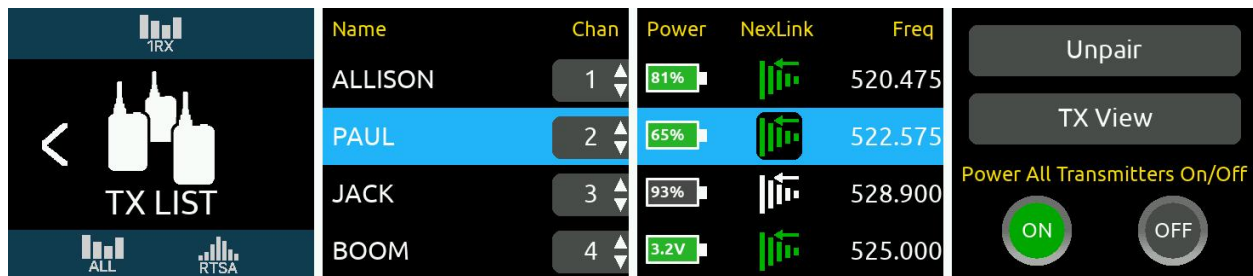

13. From the TX List, rotate the Control knob to highlight a receiver channel, then press the knob to jump to its 1RX View from which the receiver and its NexLinked transmitter can be configured and monitored.

1RX View

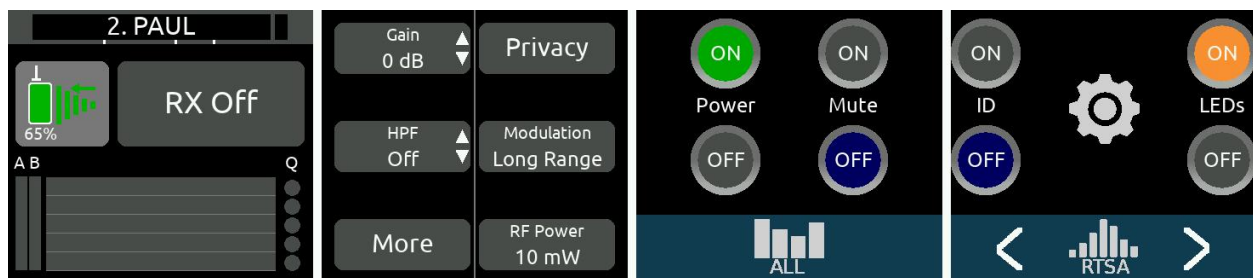

- In the 1RX View, ensure the transmitter is within NexLink range by checking that the NexLink RSSI indicator on the leftmost screen shows good signal strength.

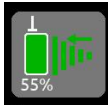

- If the A20 transmitter is not already on, tap the Power ON button on screen 3 of the 1RX View.



- Press the triangle button to access the Main Menu, then tap the RTSA icon.



- In the RTSA, rotate the Control knob (or tap the top half of the plot) to move the blue vertical frequency marker to a clean frequency (i.e. where there is low background RF noise). Press the Control knob to display the 'Assign Frequency To:' list then tap RX1 to assign the clean frequency to the required receiver channel (in this example, channel 2). The frequency is automatically pushed to the transmitter and its RF signal appears in the trace. Alternatively, select 'Auto Assign All' at the top of the list to automatically deploy clean frequencies to all active channels.

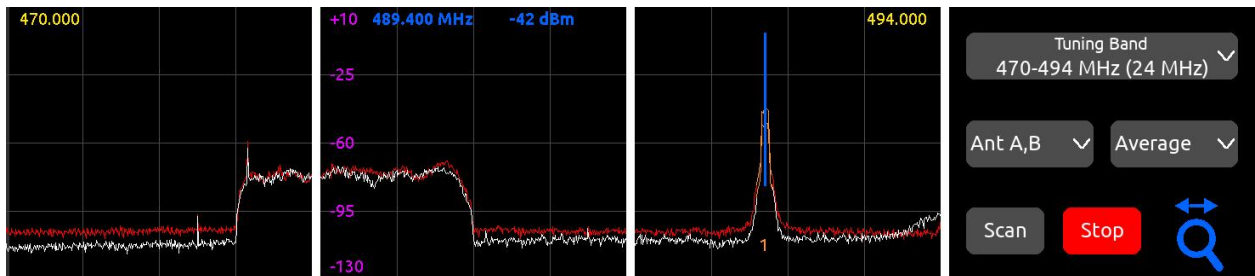
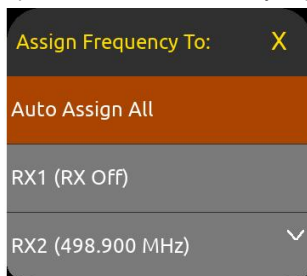

Tip: Before assigning frequencies, it is highly recommended to perform a scan of the local RF environment using Scan Mode to identify and choose a clear Tuning Band. See [RTSA > Scan Mode](#) for further information.

- Tap the orange number below the transmitter signal to jump to the 1RX View for that channel number, tap the Gain button and rotate the Control knob to bring up the gain until you see audio signal from the lav connected to the A20. Press the Control knob to store the gain value.

Congratulations! You have your first wireless channel ready to go.

Powering

The A20-Nexus Go is powered from TA4 (10-18 VDC), from the 8-Series (via expansion port), or via XL-WPTA4 AC mains adapter (purchased separately).

The control knob ring LED illuminates blue during power up, then goes out once fully booted. When the Nexus is first powered on, the last accessed RX View is displayed.

Tip: Turn off unused receiver channels to reduce power consumption. See 1RX View.

Powering when Nexus is operated standalone (not docked to an 8-Series)

Connect a 10-18 VDC power source (20 watt minimum) to the TA4 DC power input. The power source voltage is displayed beneath the Power menu icon on the Main Menu and on screen 1 of the Power menu.

- To turn Nexus on, press the triangle button or, with Power menu >'Turn on when power is applied' enabled, simply connect a power source.
- To turn Nexus off, press and hold the triangle button until the 'Powering down ..' progress bar completes.

Powering when Nexus is docked to an 8-Series

Connect power to the 8-Series. Power is supplied to the Nexus from the 8-Series expansion port.

Note: When docked, powering via the A20-Nexus Go TA4 DC input is disabled.

Ensure that the 8-Series System Menu > Expansion Port is set to On.

- If Power menu >'Turn on when power is applied' is enabled, Nexus automatically powers on when the 8-Series is turned on.
- If Power menu >'Turn on when power is applied' is disabled, turn on the 8-Series then press the triangle button to turn on Nexus.
- To turn Nexus off but keep the 8-Series on, press and hold the triangle button until the 'Powering down ...' progress bar completes.
- To turn off both the 8-Series and Nexus, move the 8-Series power toggle switch to Off.



Power Outputs DC Out 1 and DC Out 2

The DC Outs can be used for powering IFB transmitters, camera hops, and other low power peripherals. Enable or disable each DC Output from the Power menu.

- When powered via its TA4 DC input, the A20-Nexus Go supplies 500 mA maximum between both DC outputs. DC Output voltage is passed through from the DC input (10-18V).
- When powered by the 8-Series, Nexus supplies 3W maximum for each DC Output. Exceeding this limit may cause malfunction. Voltage is dependant on 8-Series power source voltage.

Navigating the A20-Nexus Go User Interface

The A20-Nexus Go is operated from its front panel triangle button, control knob, and four touchscreens.

Triangle Button

- Press to power up. Press and hold to power down.
- When Nexus is powered up, press to cycle between the RX View, Main menu, and RTSA. When on a menu or submenu, the triangle button exits to the menu above.

Control Knob

- Rotate to scroll through lists and select parameter values. Press to store.
- Rotate to scroll frequency cursor or adjust horizontal/vertical zoom in the RTSA/Scan view.

Touch Screen UI Elements

The A20-Nexus Go uses a number of different UI elements for changing settings i.e. toggle switch, list button, value button, action button, etc.

Note: When any touchscreen UI element is selected, brightness is reduced and touch is disabled on all other touchscreens.

- **Toggle Switch:** Tap to toggle between On and Off. Typically used for functions that have on and off states, e.g. Power>DC Out 1 and DC Out 2.



- **List Button:** Displays a list of items to choose from. A list button is identified by a down arrow inside the button on the right. The currently selected item is displayed inside the button.
 - Tap the list button to display a list of items to choose from.
 - Scroll the list of items by rotating the Control or tapping the up/down arrows, then press the Control knob to select the item and exit the list. Alternatively, tap directly on the list option to select it.
 - To exit the list without making any changes, press the triangle button or tap anywhere on the list's title bar.

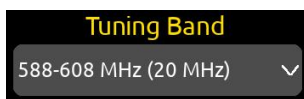

- **Value Button:** Displays a parameter's value.
 - Tap to select - the button turns orange.

- Rotate the Control knob to adjust the value.
- Press the Control knob or tap the button to exit.



- **Action Button:** A button that initiates a process, e.g. Format USB Drive. The button contains the name of the process.

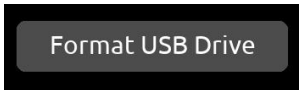

- **Two-State Button:** A button that has two values or options other than On/Off. The top row labels the function and the bottom row shows the current setting.

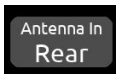

RX Views

RX Views display real-time receiver channel, transmitter signals, and status information across the four touchscreens. There are several types of RX Views:

- ALL (Displays either 4, 6 or 8 channels, depending on how many channel expansion licenses are installed)
- 4RX View (available when at least one channel expansion license is installed)
- 1RX View

Upon power up, the A20-Nexus Go shows the last displayed RX View.

ALL View

('All' View when two 2-ch expansion licenses are installed)

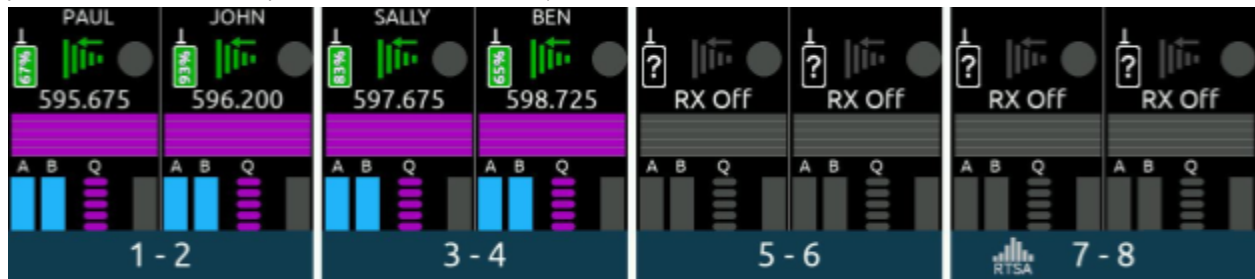

- Displays 8 receiver channel strips, two per screen.
- Tap the right arrow at the bottom of screen four to bank to the next four or eight channels (w/expansion license only).
- Tap two neighboring screens simultaneously to display the 4RX View for those receiver channels. For example, tap screen 2 and 3 simultaneously to display the 4RX View for receiver channels 3-6.
- Tap any receiver channel strip to display its 1RX View.

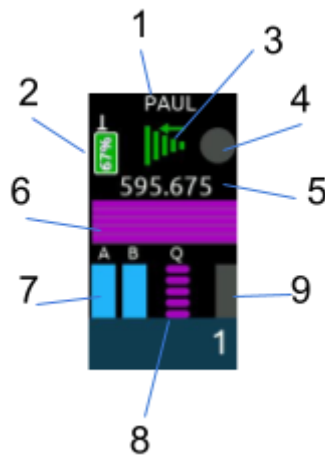

1. **Channel Name:** Displays the name of the transmitters that is currently feeding the channel.
 - a. The transmitter name can be edited if the channel is NexLinked to an A20 transmitter.
 - b. The transmitter name cannot be edited if an A10-TX is assigned to it.
2. **Transmitter Battery Level Icon:** Indicates the remaining transmitter battery charge as a color and in % or V depending on the type of battery the transmitter is using. If AA or AAA, the battery level is displayed as a voltage. If NP-BX1, then it is displayed as a %.
 - a. Gray = Transmitter is Off
 - b. Green = Good
 - c. Orange = OK
 - d. Red = Low
 - e. Flashing Red = Depleted (transmitter RF and audio are disabled)
3. **NexLink RSSI Meter:** Indicates the RSSI of the received 2.4 GHz NexLink signal from the transmitter. The RSSI color signifies the transmitter NexLink status.

- a. Green = Transmitter is on and NexLink active
 - b. White = Transmitter is off and NexLink active
 - c. Gray = No connection or out of range
4. **Record/Mute Status:** Indicates whether the transmitter feeding the receiver channel is recording and/or muted.
 - a. Red = Recording
 - b. Blue = Muted
 - c. Blue fill, red border = Recording and muted
 - d. Gray = Not recording or muted
5. **RF Frequency:** Displays the receiver channel's frequency.
 - a. If NexLinked to an A20 transmitter and NexLink Tuning Mode is set to Push, it is the same as the transmitter frequency.
 - b. Displays 'RX Off' when the receiver channel is Off.
 - c. The frequency flashes red when there is a NexLink issue. Go to the 1RX View > Gear Menu > NexLink Status screen to determine the cause of the issue.
6. **RF History:** Displays the receiver channel's RSSI or Q history. See RF Menu.
7. **A and B RSSI Meters:** Indicates the strength of the received wireless audio transmission from the transmitter.
8. **Q Meter:** Indicates the quality of the received wireless audio transmission from the transmitter.
9. **Audio Meter:** Indicates the received audio level from the transmitter. The audio meter scale is -100 to 0 dBFS for GainForward sources and -50 to 0 dBFS for non-GainForward sources.

4RX View (or ALL View when no expansion licenses are installed)

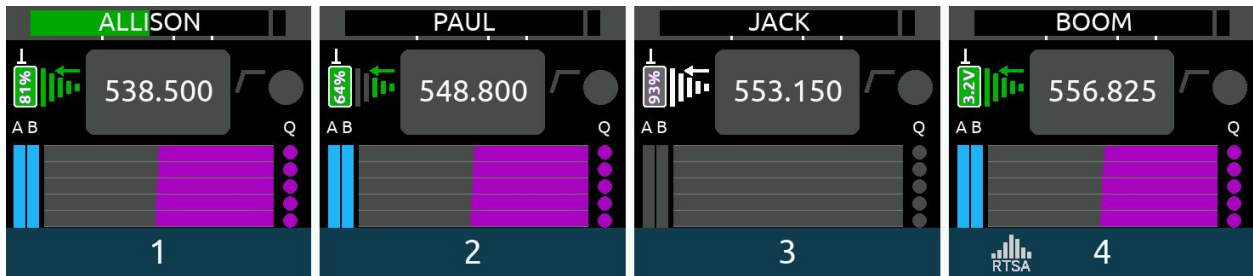

- Displays 4 receiver channels, one per screen.
- If at least one channel expansion license is installed, tap the right arrow at the bottom of screen four to go to the next bank of channels. In the next bank, tap the left arrow at the bottom of screen one to bank to the previous four channels 1-4.
- Tap any receiver channel screen to display its 1RX View.
- Tap the RTSA icon at the bottom of screen 4 to display the RTSA on screen 4.

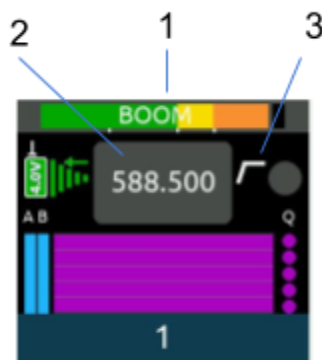

1. **Channel Name and Audio Meter:** Displays the transmitter (channel) name inside an audio level meter. Tap the meter to edit the name (12-character maximum) using the virtual keyboard.
 - a. The transmitter name can be edited if the channel is NexLinked to an A20 transmitter
 - b. The transmitter name cannot be edited if the channel is being fed from an A10-TX.



- c. If NexLinked to an A20 transmitter, the name is pushed to the transmitter.
 - d. The name is rippled to the 8-Series channel that the receiver channel is routed to if docked to an 8-Series and the 8-Series menu [Channel Setup > Use Wireless Names] is enabled.
2. **RF Frequency:** Displays the receiver channel's frequency. Tap to edit the frequency.
- a. If NexLinked to an A20 transmitter and NexLink Tuning Mode is set to Push, it is the same as the transmitter frequency.
 - b. Displays 'RX Off' when the receiver channel is Off.
 - c. The frequency flashes red when there is a NexLink issue. Go to the 1RX View > Gear Menu > NexLink Status screen to determine the cause of the issue.



- d. Tap the frequency button to select a frequency within the current Tuning Band.
- e. To enter a frequency, tap each frequency field then rotate the Control knob to select a value. Tap OK to store or Cancel to exit without saving. Alternatively, jump through the frequency fields by pressing the Control knob.
- f. To save power, turn off a receiver channel by setting the RX On/Off toggle to Off. Alternatively, in the whole number frequency field (first field), rotate the Control knob fully counterclockwise to display 'RX Off'.

If NexLinked to an A20 transmitter, the frequency is automatically pushed to the transmitter unless *System > More > NexLink Tuning Mode* is set to Manual.

- 3. **HPF:** Indicates if the HPF is active either on the transmitter (if an A10-TX) or receiver channel (if an A20 transmitter).

1RX View

Displays a receiver channel's received signal, audio level, control functions and status across the four screens.

Use the 1RX View to perform detailed control and monitoring of a receiver channel and its associated transmitter. The 1RX View has different control layouts depending on the following criteria:

- The model of the transmitter feeding the channel (A20-TX, A20-Mini, or A10-TX).
- Whether the channel is sourced from one or multiple transmitters.
- Whether the channel is sourced from a NexLinked or non-NexLinked (e.g. A10-TX) transmitter.
- Whether the channel's Mode is set to RF Only, REC Only, or RF+REC
- Whether the A20-Nexus Go is standalone or docked to an 8-Series mixer-recorder

Some 1RX View Layout examples

A20-Nexus	Mode	Description	1RX View Layout
Standalone	REC+RF	Channel sourced from a single A20 transmitter <i>(See Example 1 below for a detailed description)</i>	
Standalone	RF Only	Channel sourced from a single A20 transmitter	
Standalone	REC+RF	Channel sourced from multiple A20 transmitters <i>(See Example 2 below for a detailed description)</i>	
Docked	RF Only	Channel sourced from a single A20 transmitter <i>(expansion license installed)</i>	
Standalone	--	Channel sourced from an A10-TX or non-NexLinked transmitter	
Standalone	--	No transmitters are assigned to the channel. Tap the TX List button to assign a transmitter.	

Example 1: 1RX View when sourced from a single A20-TX transmitter in REC+RF Mode, Standalone

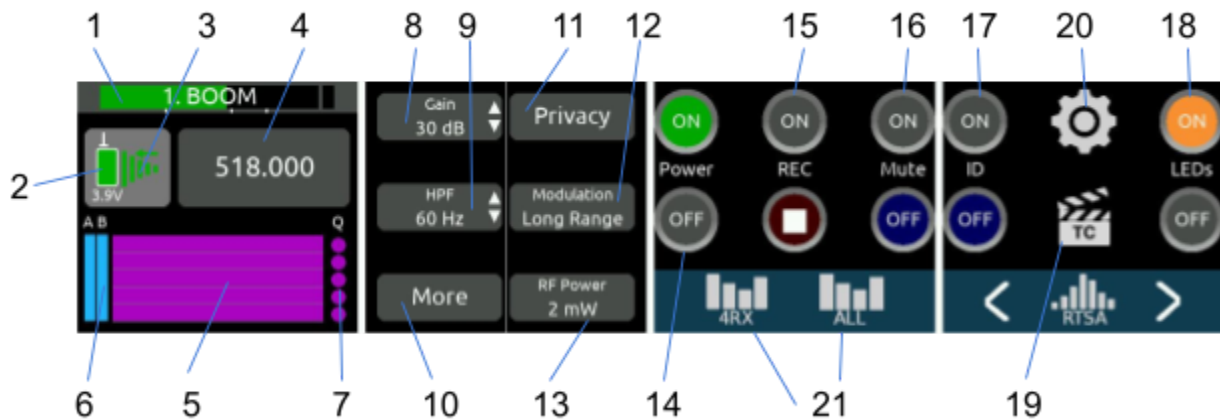

- Navigate to the next or previous channel's 1RX View by tapping the right and left arrows at the bottom of screen 4.
 - Navigate to other RX Views by tapping the RX View icons at the bottom of screen 3.
 - Tap the RTSA icon at the bottom of screen 4 to display the RTSA for the selected channel frequency in screen 4. The RTSA is approx 1 MHz wide and centered on the selected frequency. Tap the RTSA to jump to the full RTSA for the currently selected Tuning Band.
1. **Channel Name and Audio Meter:** Displays the transmitter (channel) name inside an audio level meter. Tap the meter to edit the name (12-character maximum) using the virtual keyboard. The audio meter scale is -100 to 0 dBFS for GainForward sources and -50 to 0 dBFS for non-GainForward sources, i.e. A10-TX.
 - a. The transmitter name can be edited if the channel is NexLinked to an A20 transmitter
 - b. The transmitter name cannot be edited if the channel is being fed from an A10-TX.
 - c. If NexLinked to an A20 transmitter, the name edits are pushed to the transmitter.
 - d. The name is rippled to the 8-Series channel that the receiver channel is routed to if docked to an 8-Series and the 8-Series menu [Channel Setup > Use Wireless Names] is enabled.
 2. **Transmitter Battery Level Icon:** Indicates the remaining transmitter battery charge as a color and in % or V depending on the type of battery the transmitter is using. If AA or AAA, the battery level is displayed as a voltage. If NP-BX1, then it is displayed as a %.
 - a. Gray = Transmitter is Off
 - b. Green = Good
 - c. Orange = OK
 - d. Red = Low
 - e. Flashing Red = Depleted (transmitter RF and audio are disabled)
 3. **NexLink RSSI Meter:** Indicates the RSSI of the received 2.4 GHz NexLink signal from the transmitter. The RSSI color signifies the transmitter NexLink status.
 - a. Green = Transmitter is on and NexLink active
 - b. White = Transmitter is off and NexLink active
 - c. Gray = No connection or out of range

For receiver channels that are sourced from a single transmitter, tap the NexLink RSSI meter to display the NexLinked Transmitter List from which you can select an A20 transmitter to NexLink to.



4. **RF Frequency:** Displays the receiver channel's frequency.
 - a. The frequency flashes red when there is a NexLink issue. Go to the 1RX View > Gear Menu > NexLink Status screen to determine the cause of the issue.
 - b. Tap the frequency button to select a frequency within the current Tuning Band.



- c. To enter a frequency, tap each frequency field then rotate the Control knob to select a value. Tap OK to store or Cancel to exit without saving. Alternatively, jump through the frequency fields by pressing the Control knob.
- d. To save power, turn off a receiver channel by setting the RX On/Off toggle to Off. Alternatively, in the whole number frequency field (first field), rotate the Control knob fully counterclockwise to display 'RX Off'.

If NexLinked to an A20 transmitter, the frequency is automatically pushed to the transmitter unless *System > More > NexLink Tuning Mode* is set to Manual.

5. **RF History:** Displays the receiver channel's RSSI or Q history. See *Menu > RF*.
6. **A and B RSSI Meters:** Indicates the strength of the received diversity signal from the transmitter.
7. **Q Meter:** Indicates the quality of the received diversity signal from the transmitter.
8. **Gain:** Adjusts receiver channel gain, -6 to 60 dB. Unavailable when docked to an 8-Series; use 8-Series channel trim gains instead.
9. **HPF:** Adjusts receiver channel HPF (Off, 40, 60, 80, 100, 120, 160, 200 Hz). Unavailable when docked to an 8-Series; use 8-Series channel HPF instead.
10. **More:** Tap to access a second page of settings including:
 - a. **Polarity:** Adjusts the polarity of the channel audio between Normal and Reverse. Unavailable when docked to an 8-Series; use 8-Series channel polarity instead.
 - b. **Audio Offset:** This setting is only available in a transmitter's TX View and when the transmitter is assigned to an RX channel with more than one transmitter assigned. The audio offset is a value stored in the A20 transmitter that tells the receiver channel it is feeding to apply a gain offset to the incoming transmitter audio signal. When a receiver channel has multiple transmitters assigned, this can be used to compensate for the different transmitter audio output levels resulting from microphones/lavs with different sensitivities.
 - c. **Mode:** Sets a NexLinked A20 transmitter's Mode. Options are RF only, REC only, and REC+RF (non-US TX models only or A20-TX models not set to Lav).
 - d. **More:** Tap to access the first page of settings.
11. **Privacy:** Tap to set a Privacy Key. This prevents unauthorized A20 receiver users deciphering the transmitter audio signal. Tap New Key to generate a random 4-digit key or Clear Key, to reset to zeros. The key is pushed to NexLinked transmitters assigned to the receiver channel.



12. **Modulation:** Sets Modulation between Standard and Long Range. Compared to Standard Modulation, Long Range Modulation has better sensitivity. This increased sensitivity results in better range in challenging RF environments. The Modulation setting must match between the transmitter and the Nexus in order for the transmitted signal to be received.

If NexLinked to an A20 transmitter, the modulation setting is automatically pushed to the transmitter unless *System > More > NexLink Tuning Mode* is set to Manual.

13. **RF Power:** Sets a NexLinked A20 transmitter's RF power. Options are RF Off, 2 mW, 10 mW, 20 mW, 40 mW.
14. **Power On/Off Buttons:** Tap to power on and off the transmitter and receiver channel.
15. **Record Start/Stop Buttons and Status:** Tap to start and stop the transmitter recording. Record button is red when recording. The record stop/start buttons are not displayed when the A20 transmitters are in RF Only mode.
16. **Mute On/Off buttons:** Tap to mute and unmute the transmitter.
17. **ID On/Off Buttons:** Tap to identify the A20 transmitter. Its LEDs will start flashing.
18. **LEDs On/Off buttons:** Tap to enable or disable the A20 transmitter's LEDs.
19. **Transmitter Timecode Status (only available in Rec Only or Rec+RF mode):** Tap the TC Icon to display whether the A20 transmitter has synced successfully to the A20-Nexus Go. Displays 'TC synced' when successfully synced. Tap again to return to the TC Icon.

Note: A20 transmitters hold their synced timecode accurately for 4 hours after power down, then reset.



20. **Gear Menu:** Provides access to two pages of other transmitter settings plus NexLink Status alerts. Available options depend on A20 transmitter model, A20-Mini or A20-TX.

Gear Menu Page 1/2

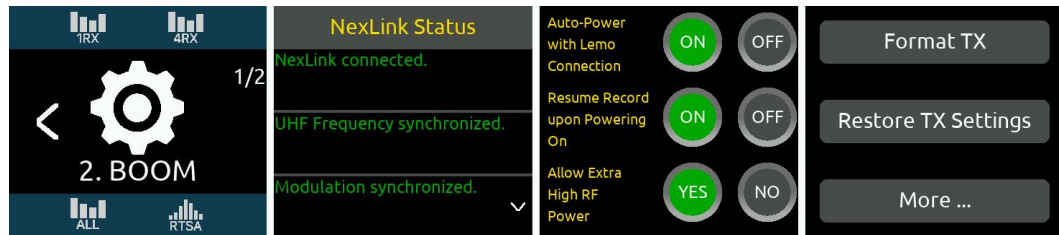

- a. **NexLink Status:** Displays various status alerts relating to communication over NexLink. See [NexLink Status Alerts](#)
- b. **Auto-Power A20 with Lemo Connection:** Set to ON to have the A20 transmitter automatically power on when a lav mic is connected.
- c. **Resume Record upon Powering On:** Set to ON to have the A20 transmitter automatically resume recording on power up if it was recording prior to powering down.
- d. **A20 Allow Extra High RF Power:** Allows the selection of 40 mW for RF Power. Rarely required.
- e. **Format TX:** Sends a command to the A20 transmitter to format its recording media. Select OK or Cancel at the 'Are you sure you want to format?' prompt.
- f. **Restore TX Settings:** Sends a command to the A20 transmitter to restore its setting to factory defaults.
- g. **More ...** Selects Page 2/2. Available options depend on A20 transmitter model, A20-Mini or A20-TX.

Page 2/2 for A20-Mini

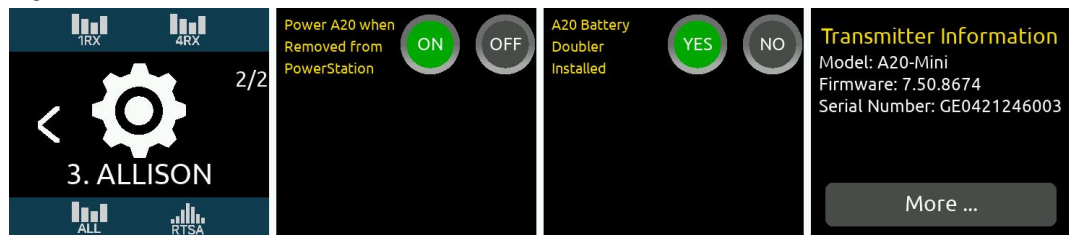

- h. **Power A20 when Removed from PowerStation:** A20-Mini Only. Set to ON to have an A20-Mini transmitter automatically power on when removed from a PowerStation-8M. Not available for the A20-TX transmitter.
- i. **A20 Battery Doubler Installed:** A20-Mini Only. When set to YES, the battery remaining % indicator adapts to the A20-BatteryDoubler's discharge characteristics in order to provide accurate readings.
- j. **Transmitter Information:** Displays the NexLinked transmitter's model, firmware version and serial number.

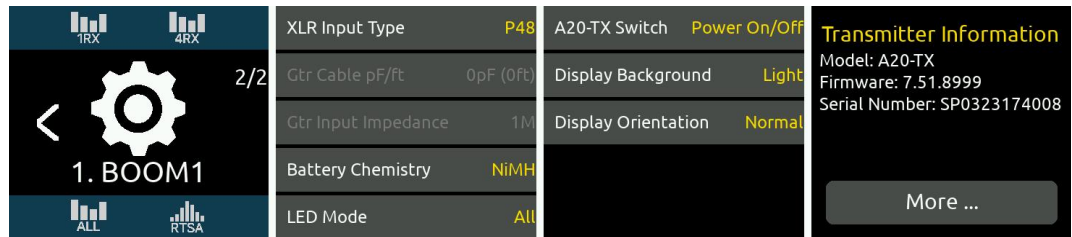

- a. **XLR Input Type:** A20-TX Only. Select Mic, Line, P12, P48, AES3-1, AES3-2, AES42-1, or AES42-2. If Lav or Guitar are connected to the A20-TX, they are automatically selected. When a Guitar is detected, the Guitar Cable Capacitance and Input Impedance options below are un-grayed.
- k. **Battery Chemistry:** A20-TX Only. Selects chemistry type: NiMH, Alkaline, Lithium Primary or Li-ion, LiFE.
- l. **LED Mode:** A20-TX Only. Select from On, Front Only, or Top Only
- m. **A20-TX Switch:** A20-TX Only. Selects the function of the optional toggle switch. Select from None, Power On/Off, Mute On/Off, Record/Stop, and RF On/Off.
- n. **Display Background:** A20-TX Only. Selects Light or Dark background color
- o. **Display Orientation:** A20-TX Only. Select between Normal or Flipped.

21. **RX View Navigation Icons:** Tap to navigate to another RX View. The 4RX icon is only displayed if the A20-Nexus Go has at least one 2-ch expansion license installed.

Example 2: 1RX View when sourced from multiple A20 transmitters in REC+RF Mode, Standalone

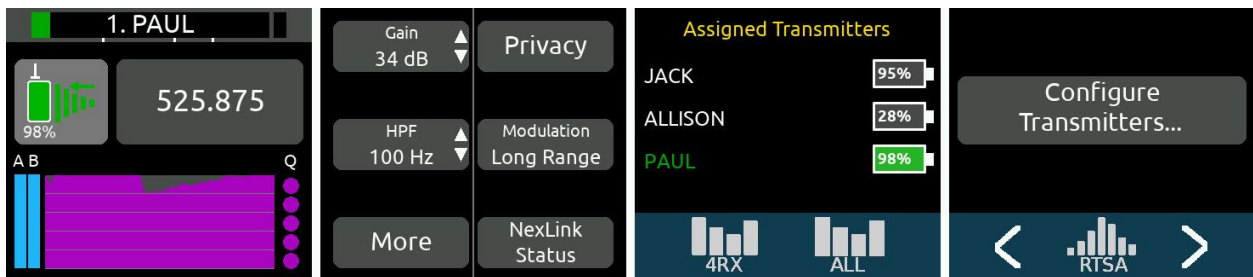

Many of the controls are the same as those described in Example 1. However, this 1RX View displays only those functions that are common to the receiver channel and all assigned transmitters. To change settings pertaining to only one of the assigned transmitters, tap 'Configure Transmitters...', highlight the transmitter, then tap TX View. The TX View can also be accessed from the TX List.

When a receiver channel is sourced from multiple transmitters, the Assigned Transmitters list in OLED 3 displays a list of all assigned transmitters. The transmitter name shown in OLED 1 and the one shown in green font in the Assigned Transmitters list, is the transmitter that is currently being received by the channel over the forward link.

Frequency, Modulation, and Privacy settings are applied to all assigned transmitters when NexLink Tuning Mode is set to Push.

Note: Make sure to have only one assigned transmitter powered up at a time otherwise they will interfere with one another. Power On/Off buttons are conveniently included in the view accessed by tapping 'Configure Transmitters...', to make it easy to ensure only one transmitter is powered on at a time: select a transmitter in the list then tap the power ON or OFF buttons as necessary.

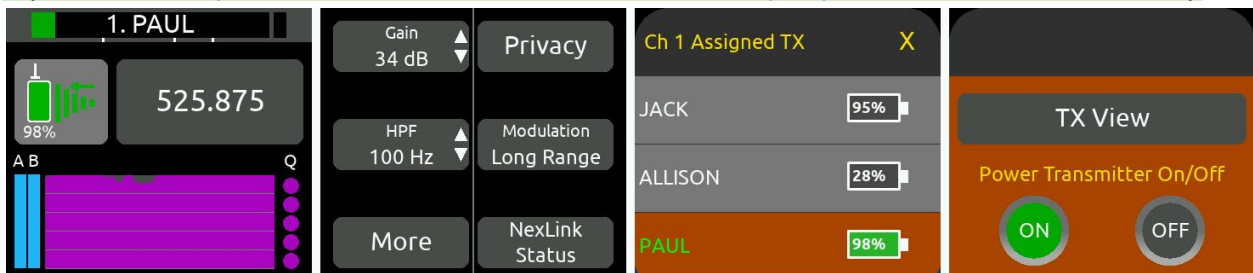

Menus

All the A20-Nexus Go settings are organized into menus that are accessed via the top level Main Menu.

The triangle button cycles between the current RX view, Main Menu, and RTSA. Press the triangle button one or two times to display the Main Menu. The leftmost touchscreen displays icons for the various RX views. Tap an RX View icon to jump to its RX View.

Main Menu

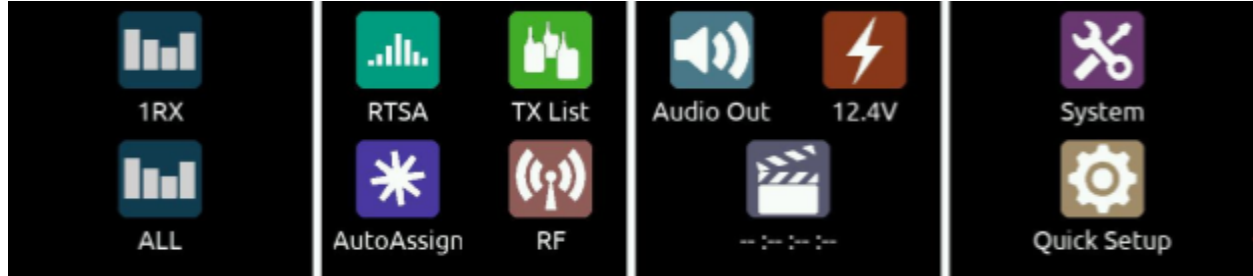

Menu	Description
1RX	Displays a receiver channel’s received signal, audio level, control functions and status across the four screens. See Operating the A20-Nexus Go
4RX	Only available if expansion licenses are installed. Displays 4 receiver channels, one per screen.
ALL	Displays 4, 6, or 8 channels depending on how many 2-ch expansion licenses are installed.
RTSA	Displays the Real Time Spectrum Analyzer, a real time spectrum analysis tool for assisting in frequency coordination and selection of clean tuning bands and RF frequencies.
TX List	Displays an inventory of paired transmitters and to which RX channels they are NexLinked. Pair/Unpair and view a transmitter’s settings. Power On/Off all NexLinked transmitters with one button press.
AutoAssign	Tap to automatically scan the current tuning band for clean frequencies and assign them to active channels. The clean frequencies are automatically pushed to NexLinked transmitters when NexLink Tuning Mode = Push.
RF	Accesses antenna, tuning band, and RF History settings.
Audio Out	Accesses D-Sub output, sync reference, sample rate settings, and tone generator settings.
Power	Displays the DC input voltage. Enables/disables DC Out 1 and 2 and configures whether the A20-Nexus Go should power on automatically when power is applied.
Timecode	Displays incoming LTC BNC timecode and frame rate
System	2 pages of various system settings: Page 1 includes screen, country, date/time, format USB drive, and firmware update functions. Page 2 includes operations pertaining to NexLink, Global TX Settings, installing plugins, and more.
Quick Setup	Load and Save Setup files for quick recall. Setups can be saved to 4 internal memory slots or to an external USB drive connected to the USB-A port.

Tip: When on a menu, there are two ways to back out to the menu above.

1. Press the triangle button.
2. Tap the leftmost screen (except when on the RTSA menu).

RTSA (Real Time Spectrum Analyzer)

The RTSA is a real time, visual spectrum analysis tool for assisting in frequency coordination and selection of clean RF frequencies. The RTSA can operate over the entire SpectraBand range (169 MHz to 1525 MHz). The RTSA trace represents RF signal level (in dBm) on the vertical axis and RF frequency on the horizontal axis.

It has two modes of operation:

- **RTSA:** Real time analysis of the currently selected Tuning Band while maintaining reception of multichannel wireless audio.
- **Scan:** Real time analysis of the entire or user-selectable portions of the 470-1525 MHz spectrum. All channel audio is muted while scanning.

Typical Workflow

It is recommended to first use Scan mode to find the cleanest Tuning Band, then use RTSA mode to find the cleanest frequencies within that Tuning Band. Once clean frequencies are found they can be assigned to receiver channels and their associated NexLinked transmitters directly from the RTSA View.

The RTSA View can be displayed on a single screen (touchscreen 4) or expanded across all 4 touchscreens.

Single Screen RTSA View

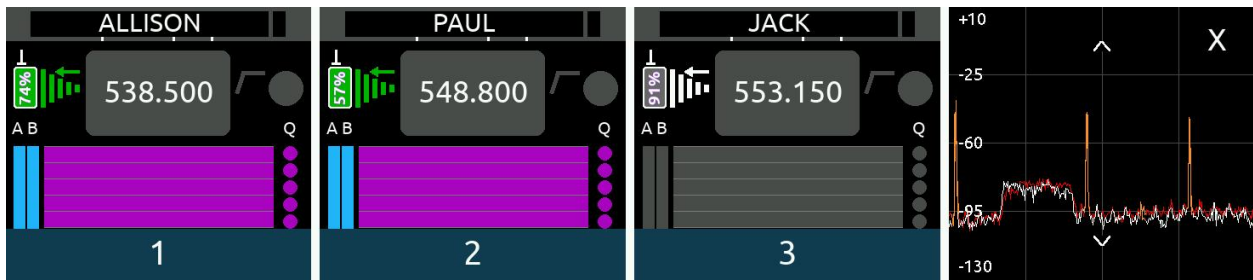

- From any RX View, show the single screen RTSA View on screen 4 by tapping the RTSA icon at the bottom of screen 4.
- Hide the single screen RTSA view by tapping the 'X' at the top right of the view.
- Change the vertical 'dBm' scale by tapping the up/down arrows.
- Switch to the expanded RTSA view by tapping the center of the screen.
- The single screen RTSA view is also displayed on the RF menu.

Expanded RTSA View

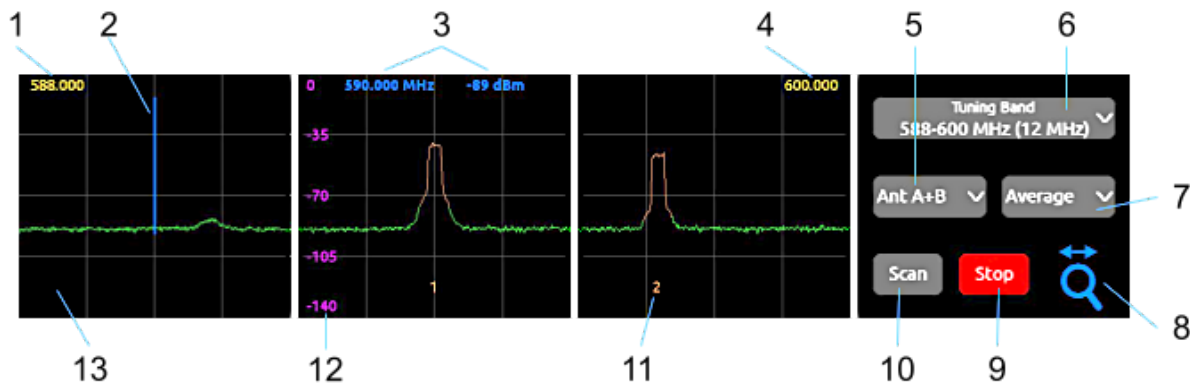

- Access the expanded RTSA View by tapping the center of the single screen RTSA View or by tapping the RTSA icon on the Main Menu or bottom of screen 1 on other menus.
- Exit the expanded RTSA View by pressing the triangle button.

1. **Minimum Frequency:** Shows the minimum frequency of the display.
2. **Frequency Marker:** Tap anywhere on the top half of the three OLEDs to locate the blue frequency marker at any desired frequency. To more precisely position the marker, rotate the Control knob with the Zoom Tool set to horizontal scroll mode (blue Zoom Tool icon). The marker can be used to identify a specific frequency and its received signal strength.

Press the Control knob to display the “Assign Frequency To:” list. Assign the blue frequency marker’s current frequency to any receiver channel or select ‘Auto Assign All’ to automatically scan and assign multiple clean frequencies at once. See [AutoAssign](#) for more information.

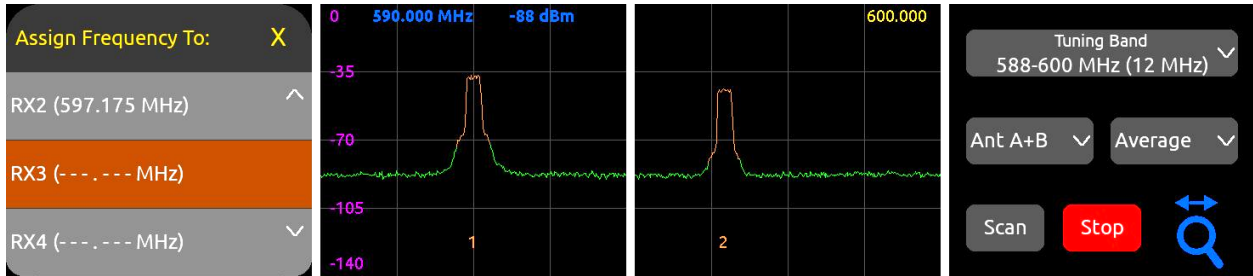

3. **Marker MHz/dBm:** Displays the Frequency Marker’s current frequency and dBm value.
4. **Maximum Frequency:** Shows the maximum frequency of the display.
5. **Antenna Options:** Selects which antenna (Ant) signals are displayed.
 - a. Ant A: Only antenna A (red line)
 - b. Ant B: Only antenna B (white line)
 - c. Ant A+B: Highest of Ant A and Ant B.
 - d. Ant A,B: Both Ant A and Ant B.
6. **Tuning Band:** Sets the A20-Nexus Go’s Tuning Band and displays its trace across the first three screens. The Tuning Band can also be set from the RF Menu.

A Tuning Band is a tightly-filtered frequency band from which Nexus’s receiver channels must operate. RF signals outside the selected tuning band are sharply attenuated to significantly reduce unwanted out-of-band RF interference. See [Architectural Overview](#) for further information

- Tap the Tuning Band button. If System > More > ‘Show Audio Off Warnings’ is enabled, a popup appears to warn that audio will stop on all channels if the Tuning Band is changed. Select OK to display a list of the currently selected Country’s Tuning Bands and their width in MHz. Country is set from the System menu.

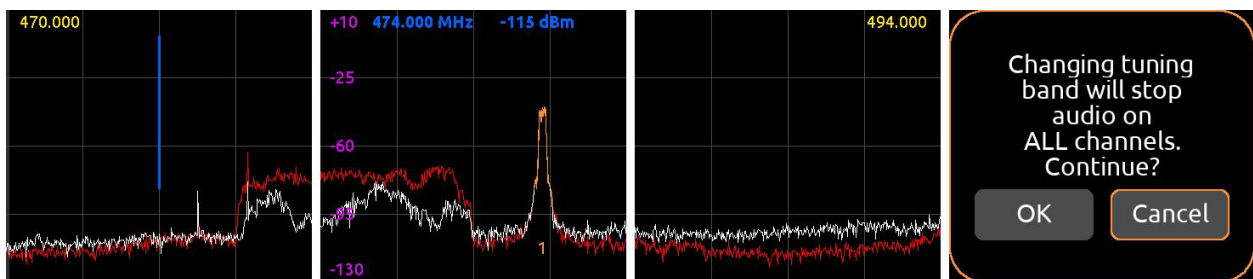

Tuning Band List

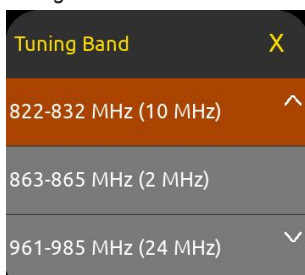

- With the Tuning Band list open, rotate the Control knob to scroll through the list. To make it easy to select a Tuning Band with the least amount of RF congestion, the Tuning Band and its RTSA display switches 'live' as the list is scrolled.
- Tap the Tuning Band list title bar to close the Tuning Band list.

Quick Recall of a Tuning Band's Assigned Frequencies

Each Tuning Band's assigned receiver channel frequencies are stored and automatically recalled when selecting a Tuning Band. This is particularly useful for:

- Quickly comparing the RF performance of assigned frequency groups as you switch between tuning bands.
- Pre-configuring alternate tuning bands with pre-assigned frequencies to prepare for unforeseen changes in the RF environment.

Note: Each Tuning Band's assigned frequency cache is cleared when Nexus is powered down.

- Trace Type:** Sets the trace characteristic. Choose from Normal, Average, or Peak Hold.
- Zoom Icon:** Tap the Zoom icon to cycle the Control knob's rotate function among the three zoom modes - marker locate (blue), zoom horizontal (yellow), and zoom vertical (pink). Tapping to locate the frequency marker automatically changes the Zoom icon to the blue marker locate function.
- Stop/Start Button:** Tap to start or stop the RTSA or Scan mode. Pressing stop freezes the current display.
- Scan/RTSA Button:** Tap to switch between RTSA and Scan modes. When switching to Scan mode, the following popup is displayed if System > More > 'Show Audio Off Warnings' is enabled.

"Changing to Scan Mode will stop audio on ALL channels. Continue? [OK, Cancel]"

- NexLink Channel Indicator:** Indicates the frequency and channel number of a NexLinked receiver channel. The channel number and frequency portion of the trace that is associated with that number is highlighted orange. Tap the orange number to jump directly to that channel's 1RX View.
- Vertical dBm scale:** Displays the vertical dBm scale. Adjust the scale using the Pink Zoom Tool. Choose from +10 to -130dBm, -10 to -130 dBm, -30 to -130 dBm, and -50 to -130 dBm
- Trace:** The real time trace of the received RF spectrum.
- Restricted Frequency Band:** Vertical gray region indicates unselectable restricted frequencies.

RTSA showing restricted frequency band

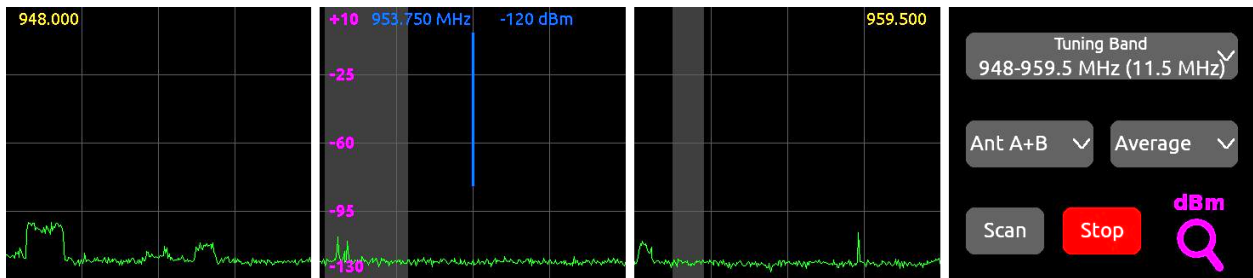

Scan Mode

Use Scan mode to view the whole Nexus 169 MHz - 1525 MHz spectrum and zoom in to see smaller sections in more detail. The complete scan trace is refreshed a few times a second. Scan mode makes it quick and easy to find and select a clean Tuning Band.

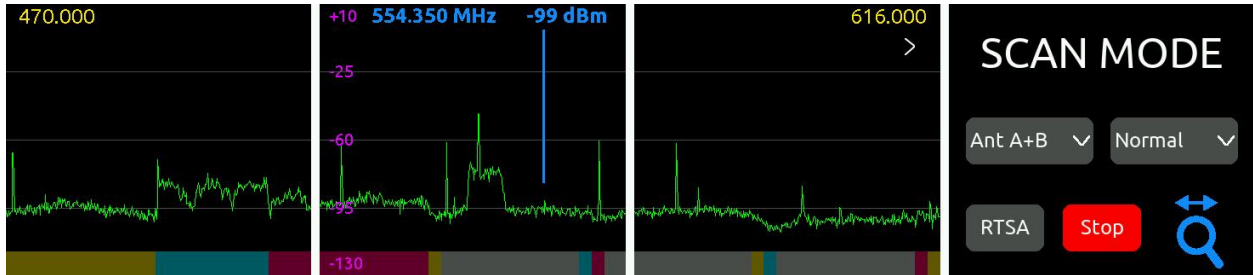

- The scan plot width is adjusted using the zoom horizontal (yellow zoom icon) tool. Scroll Control knob clockwise to zoom in and counterclockwise to zoom out.
- Tapping the '>' banks to the next range of frequencies with the same width. For example, if 470 to 616 MHz is currently displayed, tapping '>' will display 616 to 762 MHz.
- Tapping the '<' banks to the previous range of frequencies with the same width.
- When entering Scan mode, the last selected range is shown.
- The scan plot shows tuning bands as colored regions at the bottom of the display. Many tuning bands have overlapping frequencies. These overlapping frequencies are shown as gray regions.
- To select a Tuning Band:
 - Locate the vertical blue frequency marker within a Tuning Band, then press the Control knob to select the Tuning Band that the marker is located in.
 - If the blue frequency marker is located within an overlapping Tuning Band 'gray' region, pressing the Control knob will display a prompt asking to select the Upper or Lower Band. Cancel the popup by pressing the triangle button.
- When a Tuning Band is selected, the RTSA mode is automatically selected for that Tuning Band.

AutoAssign

Tap the Main Menu > AutoAssign icon to analyze the whole or part of the current tuning band for multiple clean frequencies and automatically assign them to active* channels. If System > NexLink Tuning Mode is set to 'Push to transmitter', those frequencies are automatically assigned to NexLinked transmitters. *An active channel is 1) a NexLinked channel or 2) a non-NexLinked channel that has a frequency assigned.



1. Tap the AutoAssign icon. The RTSA View appears with the full tuning band range highlighted blue. The AutoAssign Range popup is displayed on screen 4 with the Start button already selected.

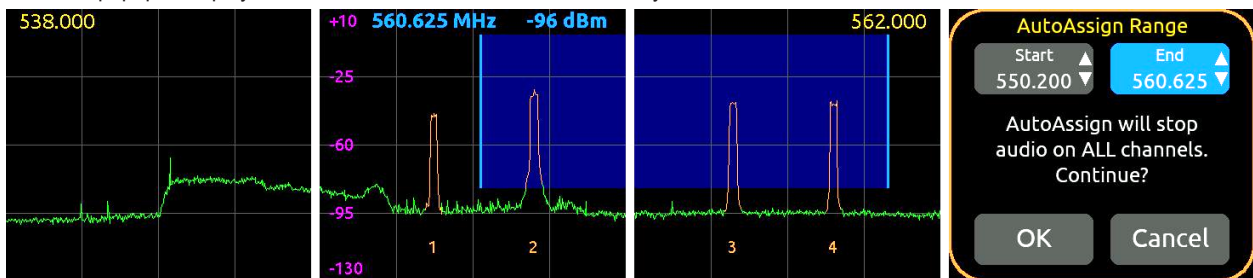

2. Tap the display or rotate the Control knob to position the AutoAssign vertical start marker at the frequency where the AutoAssign range should start.
3. Tap the End button on screen 4, then tap the display or rotate the Control knob to position the AutoAssign vertical end marker at the frequency where the AutoAssign range should end.
Note: It is not possible to select a range less than 1 MHz.
4. Tap OK to begin analyzing the selected range.
Note: AutoAssign will stop audio on ALL channels.
After a number of seconds, a popup appears showing the number of frequencies that have been assigned to channels. If clean frequencies are not found for all the active channels, the popup asks whether to assign the remaining channels to less quiet frequencies. Select OK to continue. If clean frequencies are not found for those remaining active channels after the second attempt, a third and final attempt is offered.

AutoAssign can also be instigated from the RTSA View.

1. Press the Control knob to display the 'Assign Frequency To:' list.
2. Select 'Auto Assign All'.

Note: Channels are not necessarily assigned in numerical order from lowest to highest frequency.

TX List

The A20-Nexus Go TX List is an inventory of all paired A20 transmitters and which RX channels, if any, they are assigned to. Up to 64 transmitters can be paired with the A20-Nexus Go. 'Pairing' is a process that establishes a NexLink wireless connection between the A20-Nexus Go and A20 transmitter. Once paired, an A20 transmitter can be controlled and monitored from its TX View and, if assigned to a receiver channel, from its associated 1RX View.

One or more A20 transmitters can be assigned to a receiver channel. When the A20-Nexus Go is set to 'Push' mode (see System>NexLink Tuning Mode), all transmitters assigned to a receiver channel are sent that channel's RX Frequency, Modulation, and Privacy settings. This makes it easy to quickly switch between transmitters assigned to the same receiver channel, particularly useful in live scenarios such as switching to a backup transmitter or switching between a performer's different mics or instruments that are being fed to the same channel on an external mixer.

NOTE: When multiple transmitters are assigned to the same receiver channel, ensure that only one of those transmitters is powered on, otherwise signals from these multiple transmitters will interfere with each other since they will all be operating on the same frequency.

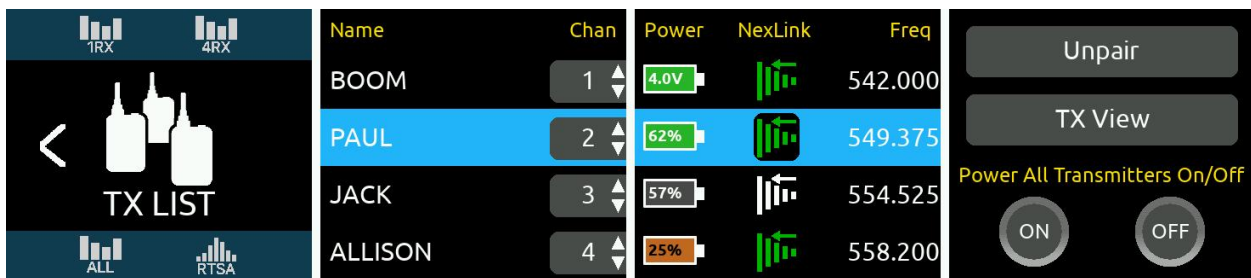

Pairing an A20 Transmitter to the A20-Nexus Go

To establish NexLink wireless control between an A20 transmitter and the A20-Nexus Go, the transmitter must be added to the TX List in a process called 'pairing'. Once paired, a transmitter can be assigned to a receiver channel. Paired transmitters that are not assigned to a receiver channel can still be controlled over NexLink via the TX View.

1. Enter the TX List by tapping the TX List icon on the Main Menu.
2. Connect the A20 transmitter's USB-C port directly to the A20-Nexus Go USB-A port or via a USB hub. It is not necessary for the A20 transmitter to be powered on or for it to have a battery installed.
3. Wait for several seconds while the A20 transmitter pairs to the Nexus. The A20 transmitter will appear at the top of the list once paired.
4. Disconnect the USB cable connecting the A20 transmitter to the Nexus.

Pairing automatically assigns the transmitter to the next available receiver channel number. Should that transmitter not be required for a particular production or job, simply un-assign it by setting its channel number to '-'. Once transmitters are paired, they remain permanently on the TX List until unpaired.

Tip: Use a USB Hub (or PowerStation-8M) to pair multiple A20 transmitters simultaneously by connecting it to the A20-Nexus Go's USB-A port.

Unpairing Transmitters from the A20-Nexus Go

Rotate the Control knob to select a transmitter on the list, then tap the Unpair button on OLED 4. An 'Are you sure ...' popup appears. Tap OK to unpair and remove the transmitter from the TX List.

TX List Description

The TX List displays the following columns:

- Name: The name of the paired transmitter. Tap to edit the name.
- Chan: The receiver channel number to which the transmitter is assigned. Tap to assign. Unassign by setting to '-'.
- Power: Displays the transmitter's power status and battery level. A battery icon with gray fill is powered off.
- NexLink: Displays NexLink status.
 - ---: Waiting to hear from the A20 transmitter
 - Connecting: Establishing NexLink communication.

- Initializing: Initializing connection.
- NexLink RSSI icon: NexLink communication established. Displays the quality of the NexLink signal.
 - When TX is on, the RSSI level display is green
 - When TX is off but NexLink is active, the RSSI level display is white
 - When TX has no Nexlink communication, the RSSI level display is gray.
- Freq: Displays the transmitter's frequency.

The TX List is sorted according to ascending receiver channel (Chan) number. When multiple transmitters are assigned to the same receiver channel, they are sorted in alphabetical order within that channel number's group.

Assigning a Paired Transmitter to a Receiver Channel

Assigning a paired transmitter to a receiver channel enables synchronization of frequency, modulation, and privacy settings between the transmitter and that receiver channel. Up to 16 transmitters can be assigned to the same receiver channel.

1. Rotate the Control knob to select a transmitter, then tap the 'Chan' box.
2. Rotate the Control knob to choose a channel number, then press the Control knob to store.
 - a. If the selected receiver channel has no transmitters already assigned, the selected transmitter is immediately assigned to that channel.
 - b. If the selected receiver channel already has one or more transmitters assigned to it, a popup is displayed on OLED 3 prompting whether the selected transmitter should be assigned to that receiver channel too. Click OK to assign.

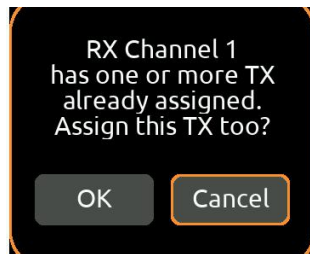

- c. If you are only working with a single transmitter per receiver channel, you can select that single transmitter directly from that channel's 1RX View. In the 1RX View, tap the NexLink Icon to display the 'NexLinked Transmitter' List from which you can select an A20 transmitter.

Tip: Rotate the Control knob to scroll through the TX List. Select a transmitter by highlighting its row, then press the Control knob to jump directly to its receiver channel's 1RX View.

Tip: The TX List icon on the Main Menu is yellow if not all transmitters are connected and green when all transmitters are successfully connected or when no transmitters have been paired. If using the A20-Remote app for control, it is best practice to fully close the A20-Remote app or disable transmitter control in the app's Manage Transmitters view until transmitters are shown as connected in the TX List.

TX View Button

Tap the TX View button to access the selected transmitter's settings. The button is grayed out when the transmitter is not connected via NexLink. TX settings can also be accessed via the 1RX View of the receiver channel that the transmitter is assigned to.

For a detailed description of many of the TX View's controls that it shares in common with the 1RX View and its Gear menu, see [1RX View](#).



Power All Transmitters On/Off Buttons

Tap On to power on all NexLinked transmitters. Tap Off to power off all NexLinked transmitters.

Note: If multiple transmitters are assigned to a receiver channel, only the last transmitter being received over the forward link is powered on.

RF Menu

The RF Menu accesses antenna, tuning band, and RF History settings. From the Main Menu, tap the RF icon to enter the RF Menu.

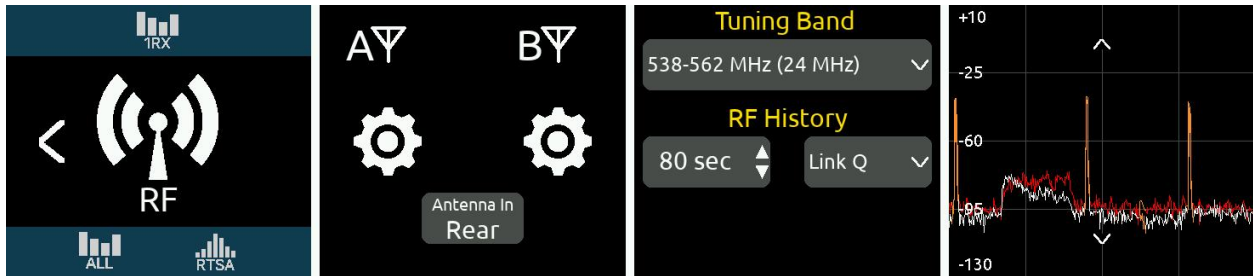

Antenna A/B Setup

The antenna inputs A and B can be switched as a pair between the front or rear panel BNCs. When set to front, the antenna's matching rear BNC can be set to Cascade Out, ideal for daisy chaining units.

When daisy chaining A20-Nexus Go, it is recommended to use an external powered antenna to overcome the 3 dB splitting loss in the Nexus so that the receivers maintain excellent range.

- **Antenna In button:** Tap to toggle between the Front and Rear BNCs for the A and B antenna inputs.
- **A,B Gear Icons:** Tap to access settings for the A and B antennas.
 - **Power (Bias):** Provides 12V DC bias power for active or smart antennas. When On, a lightning power icon appears next to the antenna's icon in the RF Menu. When setting Power (Bias) to On, a "Turn on Antenna Bias Power" prompt is displayed. Select OK to turn on bias power.
 - **Cascade out:** When the Front/Rear antenna input button is set to Front, the rear BNCs can be set as Cascade outs for daisy chaining units. The Cascade out option is grayed out when the antenna BNC inputs are set to Rear.
 - **Smart Antenna:** Tap to enable remote control of the Wisycom LFA smart antenna. The LFA control settings are grayed out when Smart Antenna is disabled. After turning power bias On, allow about 20 seconds for the smart antenna fields to become accessible.
 - **LFA Gain Mode:** Sets gain of Antenna A or B in 1 dB steps. [Off, Bypass, -12 to 27dB].
 - **LFA Gain:** Sets gain of Antenna A or B in 1 dB steps. [Off, Bypass, -12 to 27dB].
 - **LFA Filter Type:** Sets the filter type of Antenna A or B. [WB (Selected in Freq field: 410-810, 410-700, 410-600, 470-810, 470-700, 470-600, 510-810, 510-700, 510-600); NB (940-960MHz, freq is fixed at 940-960 and cannot be changed)].
 - **LFA Filter Freq:** Sets the filter freq of Antenna A or B. [When Filter is set to NB, Frequency is fixed at 940-960 and cannot be changed. When Filter is set to WB, Freq can be set to 410-810, 410-700, 410-600, 470-810, 470-700, 470-600, 510-810, 510-700, 510-600. When Filter is set to Tunable, Filter Frequency can be adjusted in 40 MHz blocks from 410-450 to 690-730 in 1 MHz steps.]
 - **LFA Name:** Displays name of Antenna A/B.
 - **LFA Display Brightness:** Sets Antenna A/B display brightness in increments of 1. [1-10]
 - **LFA Display Color:** Sets Antenna A/B display color. [White, Black]
 - **LFA Display Timeout:** Sets the duration of Antenna A/B display timeout in steps of 1 second. [5 to 240 seconds]
 - **LFA Display Rotate:** Sets the rotation of the Antenna A/B display. [0 or 180]
 - **LFA LED:** Sets Antenna A/B LED activity. [On or Off]
 - **LFA Version Info:** Displays system information about the Wisycom LFA- B-F1.
- **Tuning Band:** Sets the A20-Nexus Go's Tuning Band and displays its trace across the rightmost screen. The Tuning Band can also be set from the RTSA. See [RTSA](#) and [Architectural Overview](#) for more information.
- **RF History:** The RF History plot is displayed in the 1RX, 4RX, and 8RX Views. It displays RF signal level (RSSI) or link quality history over a specified duration.

- **Duration:** Set from 30 to 600 seconds in 10-second steps.
- **Type:** Choose from the following:
 - RSSI A/B: Displays Antenna A or B's RSSI, whichever is the highest.
 - RSSI A: Displays Antenna A's RSSI
 - RSSI B: Displays Antenna B's RSSI
 - Link Q: Displays Link Quality

Antenna RF Overload Indication

The A20-Nexus Go indicates whether its A and B antenna inputs are approaching overload or overloading.

- Red = Overload
- Orange = Approaching overload

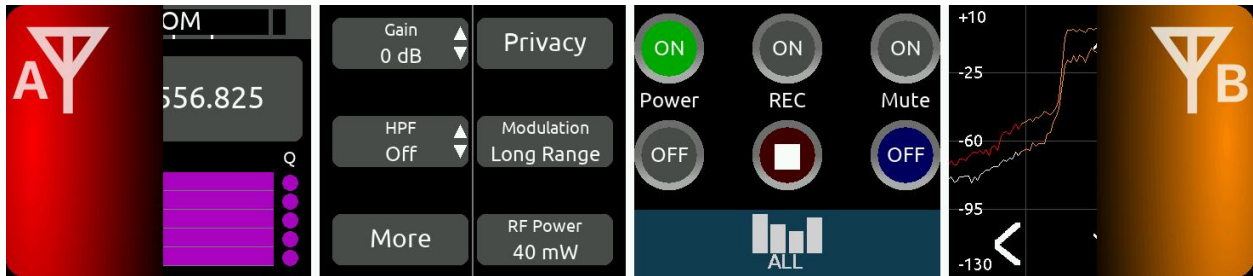

- Left indicator (on OLED 1) = A antenna overload status
- Right indicator (on OLED 4) = B antenna overload status
- The red and orange indicators are held for a minimum of 2 seconds. Tap the indicator to manually clear it for at least 10 seconds.

Tip: Things to try when an RF signal is approaching overload or overloading an antenna input:

- Increase the distance between transmitter and receiver antennas
- Reduce RF power on the transmitter
- If using amplified external antennas, reduce the amplifier gain
- Use the RTSA screen to examine from where the interference is coming. If the interference is not from the transmitters in use but rather some other sources, consider changing the tuning band and frequency so the interfering RF signal is moved out of band.

Audio Outputs

When standalone, the A20-Nexus Go delivers its multichannel receiver audio via analog and AES outputs.

When docked to an 8-Series mixer-recorder, the A20-Nexus Go's multichannel receiver audio is outputted via the expansion port to the 8-Series and A20-Nexus Go's analog and AES outputs are disabled.

Audio Outputs are configured in the Audio Out Menu.

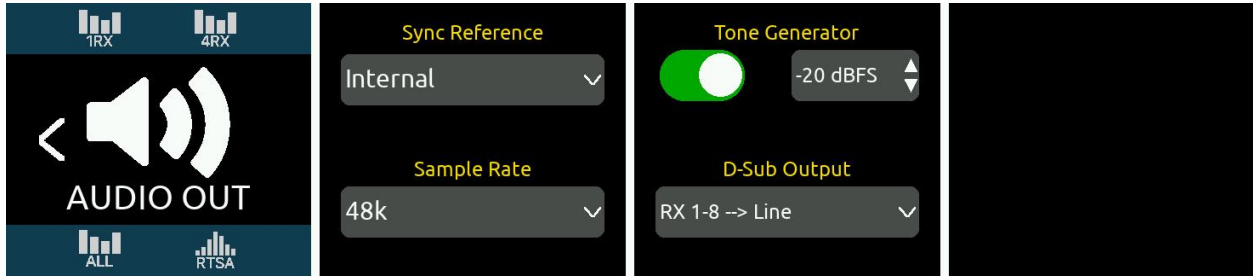

Routing A20-Nexus Go Receiver Audio when Docked to an 8-Series Mixer-Recorder

From an 8-Series channel screen, select any one of the A20-Nexus Go's receiver outputs as channel source. A20-Nexus Go receiver outputs are only shown when an A20-Nexus Go is docked via the expansion port and enabled via the 8-Series System > Expansion Port menu.

833 Mixer-Recorder Channel Screen

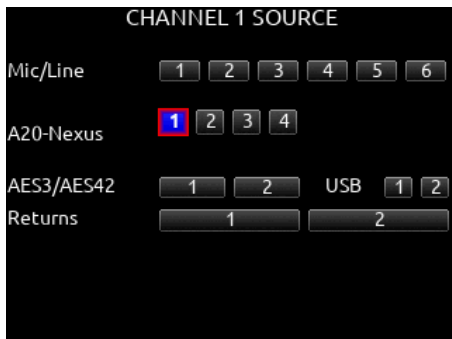

Routing A20-Nexus Go Receiver Audio to Analog or AES Outputs

The A20-Nexus Go's D-Sub 25-pin connector can be set to output receiver channel audio as analog (line, -10, mic level) or AES signal.

Configure what to output from the D-Sub connector in the Audio Out > 'D-Sub Output' list. The options are:

- Disabled
- RX 1-4 → Line
- RX 1-4 → 10
- RX 1-4 → Mic
- RX 1-4 → AES
- RX 1-4 → Guitar

Note: RX 5-6 or RX 5-8 options are available to select if 2-channel expansion licenses have been installed.

Audio Out Sample Rate

- The sample rate of the AES digital outputs is determined by the Audio Out > Sample rate and Sync Reference settings.
- The Nexus outputs digital audio at 44.1, 48, or 96 kHz sample rates. Factory default is 48 kHz.
- The sample rate can only be set when the Sync Reference is set to Internal or BNC In (when receiving timecode). Otherwise, the sample rate field is read-only.

Audio Out Sync Reference

The A20-Nexus Go's AES outputs can be synced to the following sync reference sources:

- Internal
- BNC In (Word Clock or LTC). The A20-Nexus Go auto-detects whether the incoming signal is word clock or timecode
- 8-Series (automatically selected when docked to an 8-Series)

The following table indicates how the digital output sample rate is determined for each type of sync reference source:

Sync Reference	A20-Nexus Go Sample Rate Setting
Internal	44.1k, 48k or 96k
BNC In (Word Clock)	Determined by incoming Word Clock frequency
BNC In (LTC)	44.1k, 48k or 96k
8-Series (automatically selected when docked to 8-Series)	Determined by the 8-Series sample rate. Timecode and sync reference are received from the 8-Series.

- If the selected sync reference input is not detected, the A20-Nexus Go switches to its internal clock AND the Control knob ring LED flashes orange to indicate that the selected sync reference is not present or invalid.
- When synced to Internal, the BNC In can still be used as an LTC source.

Tone Generator

Enable the Tone Generator to send tone at a specific level to all audio outputs. The tone level can be adjusted from -20 to 0 dBFS

Timecode

With NexLink, the A20-Nexus Go is able to simultaneously sync multiple A20 transmitters when they are set to REC only or REC+RF mode. This feature ensures zero-frame drift between multiple recording transmitters, therefore making it easy to sync with picture in post, especially when the free SD-Utility software tool (<https://www.sounddevices.com/sd-utility-v2-00/>) is used to conform and merge the individual A20 transmitter recordings into a single polyphonic wav file.

The Timecode menu displays incoming LTC and its frame rate. Tap the timecode slate icon on the Main Menu to access the Timecode menu. The incoming timecode is displayed below the icon making it unnecessary to enter the Timecode menu to check that valid timecode is being received.

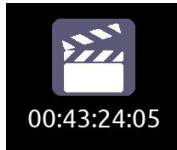

The A20-Nexus Go receives timecode in two possible ways:

1. **From the rear panel LTC/WCK BNC In port.** The A20-Nexus Go automatically detects whether a word clock or timecode signal is connected. When the source is timecode, the frame rate is automatically detected.
2. **From the 8-Series when docked via the expansion port.** When docked to the 8-Series, the A20-Nexus Go's BNC In port is disabled and timecode and sync are received from the 8-Series. Use the 8-Series Timecode/Sync menu to set up timecode and sync as necessary.

Syncing A20 transmitters to A20-Nexus Go timecode.

- The A20-Nexus Go will automatically sync timecode to all A20 transmitters when a timecode source is plugged into the BNC In port. When synced, the A20 transmitters blink their blue timecode LED for about 10 seconds and the Nexus displays 'TC synced' in transmitter 1RX View > TC menus (accessed by tapping the TC Icon).
- An A20 transmitter is also synced from the A20-Nexus Go by connecting its USB-C port to the A20-Nexus Go USB-A port while in the Timecode menu. When connected, the Timecode Menu displays a Sync A20 button at the bottom of screen 4.



Only available when the A20 transmitter is connected to the USB-A port

- The top of screen 1 displays how many of the NexLinked transmitters are synced.

System Menu

Tap the System Icon in the Main menu to access System settings. The System menu has two pages and includes various system settings organized over two pages. Switch between the pages by pressing the 'More ...' button.

System Menu Page 1

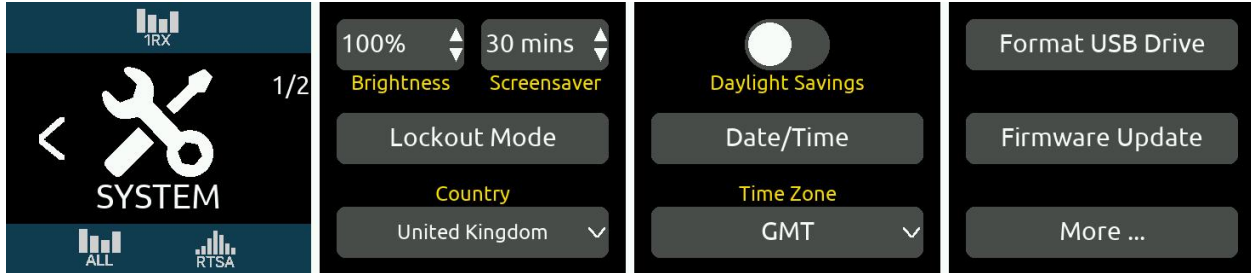

Brightness

Tap to adjust the brightness of the OLED array and the LEDs.

Screensaver

The screensaver can help prevent OLED burn in. The screensaver time sets the duration from when the OLEDs were last touched to when the OLEDs display the screensaver. Select between 1 min, 5 mins, 15 mins, 30 mins, and never. The screensaver is canceled upon the touch of any front panel control.

Lockout Mode

Enable Lockout Mode to prevent unauthorized or accidental access to front panel controls including OLEDs, Control knob, and triangle button. Lockout mode can be enabled locally or via the web app.

When Lockout mode is enabled, the Control knob ring LED is backlit green to indicate that the A20-Nexus Go is still on.

To enable Lockout mode from the Nexus, tap the Lockout Mode button. The following popup is displayed:

“Are you sure?
To disable Lockout, tap the
left display whilst pressing
the Control knob.
OK, Cancel”

To disable Lockup Mode, tap the left display while pressing the Control knob.

Country

The Country setting determines which Tuning Bands and RF frequencies are legally available for selection. To set, tap the Country button then select the Country that you are in. Nexus displays the following prompt:



The Nexus will change the country and automatically restart when OK is selected.

Important

- The A20-Nexus Go and its paired A20 transmitters must be set to the same country for the Nexus to successfully set the transmitter frequencies via NexLink.
- To set Country for the A20 transmitters, use the A20-Remote app. Refer to the A20 transmitter user guides for more information.
- Changing the Country setting sets the current tuning band to the default (lowest) tuning band for that Country.
- If the A20-Nexus Go and an A20 transmitter's country settings are not matched, a warning popup appears on OLED 1 as well as a 'Country conflict' alert on the NexLink Status screen.

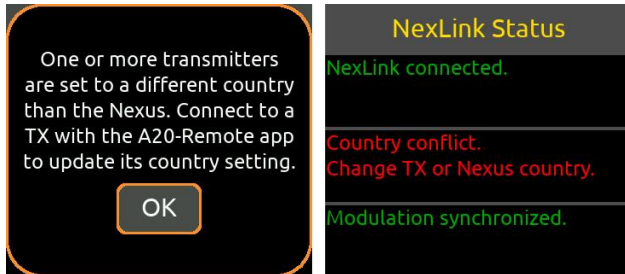

Date/Time

The A20-Nexus Go's Date/Time has two purposes:

1. Sends the date/time to A20 transmitters where the value is used to set the creation time of the A20 transmitter recorded files.
2. Sets the creation date/time of A20-Nexus Go Quick Setup files.

Tap Date/Time to bring up the Date/Time popup, then enter MM/DD/YY and HH/MM/SS. In each field, rotate the Control knob to set a value, then press the Control to jump to the next field. Tap Done to store.



Time Zone

Set the time zone from GMT -12:00 to GMT +13:00

Daylight Savings

Tap to toggle daylight savings on/off.

Format USB Drive

A USB drive connected to the USB-A port can be used for updating firmware and saving quick setup files. Before using the USB drive, it must be formatted by the A20-Nexus Go.

- Tap Format USB drive, then select OK in the popup.
- USB Drives are formatted as FAT32.

Firmware Update

See [Updating Firmware](#)

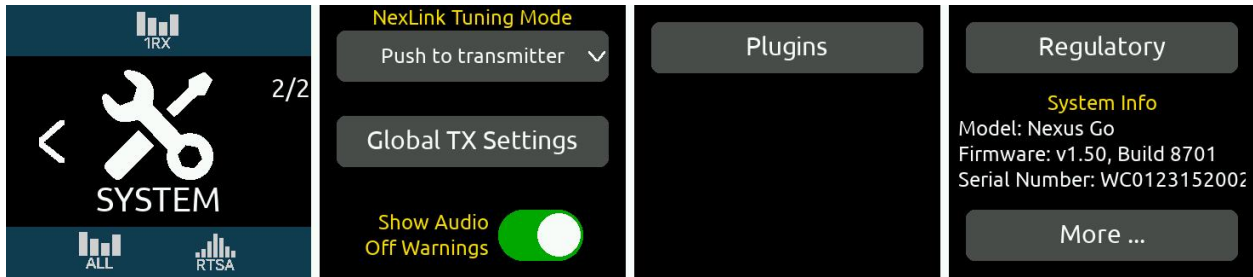

NexLink Tuning Mode

Determines whether A20 transmitter frequency, modulation, and privacy settings are automatically sent (pushed) from the A20-Nexus Go to the A20 transmitter over NexLink.

- Push to Transmitter
- Manual (must be set manually on the receiver and transmitter).

Global TX Settings

The Global TX Settings menu provides options for enabling or disabling power off or stop confirmation popups.

1. Power Off Confirmation: When set to ON, powering off a transmitter from a 1RX View displays “Are you sure?”. Tap OK to power off the transmitter. Use this function to prevent accidentally powering down transmitters.
2. Stop Confirmation: When set to ON, stopping a transmitter from recording from a 1RX View displays “Are you sure?”. Tap OK to stop the transmitter recording. Use this function to prevent accidentally stopping recording.

Show Audio Off Warnings

When the toggle is off, the A20-Nexus Go does not show a warning popup that audio will stop when switching Tuning Bands and when switching to Scan mode.

Plugins

Tap Plugins to display and install licenses and plugins.

Quick Setup Menu

Quick Setup provides a way to save and load A20-Nexus Go settings. Settings are saved to internal memory slots 1-4 or to a USB thumb drive connected to the USB-A port.

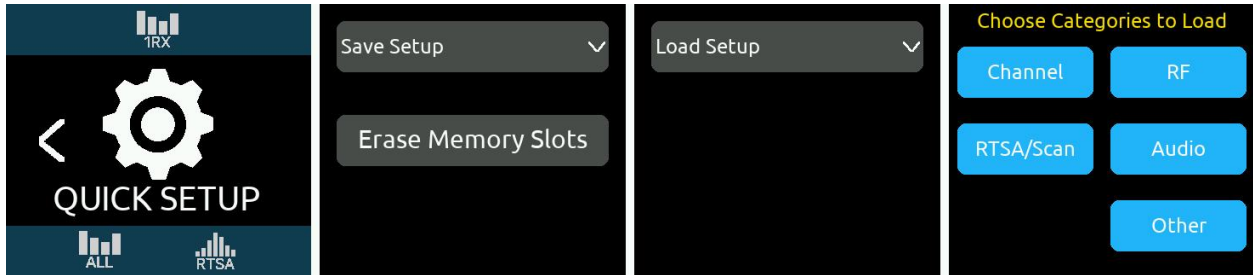

Save Setup

- All A20-Nexus Go's current settings are saved when saving a setup.
- Saving to an internal memory slot overwrites the existing setup file.
- Tap Erase Memory Slots to erase internal memory slots 1-4.
- Tap Save Setup to display a list of destinations (4 internal memory slots and USB thumb drive). Select a destination then use the virtual keyboard to name the setup. Tap Save to store the current A20-Nexus Go settings.
- During the save process, "Saving Setup ..." is displayed.

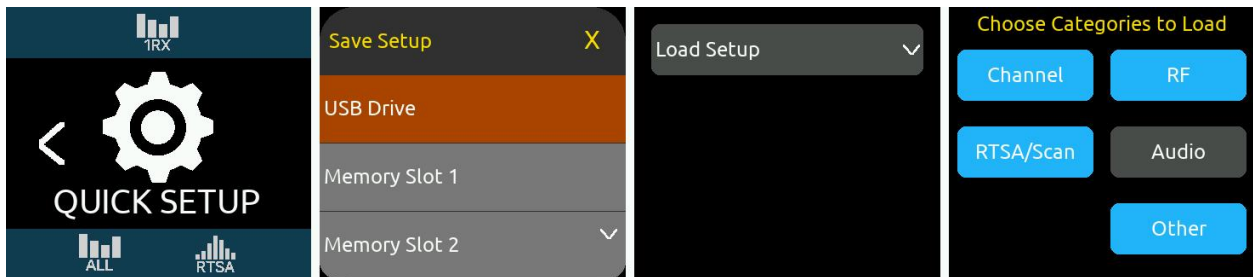

Load Setup

- Choose which categories (Channel, RF, RTSA/Scan, Audio, Network, Other) to load. This allows you to select only the settings you want to change and which ones you want to remain.
- Tap Load Setup to bring up a list of the setup files stored in the four internal memory slots and USB drive. Selecting a setup from the list loads the selected categories from that setup. During the load setup process, "Loading Setup ..." is displayed.

Categories

Channel	RF Frequency
	Modulation
	Privacy key
	RX On/Off
	Transmitters assigned to channel
	Polarity
	Gain
	HPF
RF	Rear/Front Antenna Select
	A and B Antenna Bias Power

	A and B Antenna Cascade out
	Current Tuning Band
	RF History duration
	RF History Type
	NexLink Tuning Mode (Push or Pull from Transmitter)
RTSA/Scan	RTSA/Scan Zoom Mode
	RTSA/Scan Vertical dBm Scale
	RTSA/Scan Antenna Display Selection
	RTSA/Scan Antenna Display Characteristics
	Scan Width
	Bandwidth
Audio	D-Sub Output Routing and Analog Output Level
Other	Sync Reference
	Sample Rate
	Brightness
	Screensaver
	DC Out 1
	DC Out 2
	Turn On when Power is Applied
	Time Zone
	Daylight Savings On/Off
	TX List > Global TX Settings: Power Off confirmation, Stop Confirmation

Default Settings

The Load Setup list also includes a 'Default Settings' option for restoring the A20-Nexus Go to default settings.

Updating Firmware

Periodically Sound Devices issues new firmware for the Nexus receiver. Make certain to register your product at the Sound Devices website to receive firmware update notifications.

Firmware is installed via a USB thumb drive inserted into the Nexus USB-A port. Download the latest firmware PRG from the Sound Devices website at <https://www.sounddevices.com/download/>

To update Nexus firmware

1. Download new Nexus firmware PRG file from the Sound Devices website.
2. Copy the PRG file to the root of a USB thumb drive that has been formatted by the A20-Nexus Go. See System menu.
3. Insert the USB thumb drive into the rear panel USB-A port.
4. Access the System menu and tap Firmware Update.
5. The Nexus will automatically display the PRG file. Tap OK to start the update process.
6. Once programming has finished, the Nexus will automatically restart and display "Unit has been updated." Click OK to proceed.

Channel Expansion Licenses

The A20-Nexus Go can be expanded from 4 channels to 6 or 8 channels by purchasing one or two 2-channel Expansion Licenses from the Sound Devices website. Permanent or rental licenses (7-day or 30-day) are available.

Channel Expansion licenses are installed via a USB thumb drive inserted into the Nexus USB-A port.

To install a license

1. Download the purchased license (.lic file) from the Sound Devices website.
2. Copy the license to the root of a USB thumb drive that has been formatted by the A20-Nexus Go.
3. Insert the USB thumb drive into the rear panel USB-A port.
4. Access the System menu, tap More ..., then tap Plugins.
5. Tap Install.

Once installation has finished, the A20-Nexus Go will automatically restart.

Accessories

Included

- 2x A20-Monarch Antennas
- 2x Articulating Arm with ¼"-20 mount for Mounting A20-Monarch Antennas
- 2x 30" BNC to BNC Antenna Cables
- 2x 2.4 GHz Antennas, SMA-M
- 2x A20-2.4G Ant+Mount for Mounting to Nexus Side Panels
- 4x Rubber Feet
- 1x plastic SFP Cage Protective Cover
- A20-Nexus Go Product Document
- 2x Promo Stickers

Optional

- A20-QuickDock
- A20-Monarch Antenna (inc. articulating arm, BNC to BNC cable, BNC to SMA cable)
- A20-Shelf
- 2.4 GHz Antennas, SMA-M (set of 2)
- A20-2.4G Ant+Mount
- XL-WPTA4 Power Supply
- A-VHF-Dipole-BNC (set of 2 VHF antennas)

A20-QuickDock for 8-Series

The A20-QuickDock enables the A20-Nexus or A20-Nexus Go to be docked to 833, 888, or Scorpio mixer-recorders. The bottom panel incorporates a multi-pin port that connects power from the 8-Series and passes the multichannel receiver digital audio from A20-Nexus Go to the 8-Series.

When docked on an 8-Series:

- **Power must be provided by the 8-Series - A20-Nexus Go TA4 DC input is disabled.**
- The A20-Nexus Go and its NexLinked transmitters are controlled from the A20-Nexus Go front panel or its web app. The 8-Series user interface is not used for control.
- Most A20-Nexus Go rear panel connectors are disabled, apart from the antenna connectors, the USB-A port, and the DC Outs.
- The USB-A port has the following capabilities when A20-Nexus Go is docked on an 8-Series:
 - Pairing A20 transmitters to the A20-Nexus Go by connecting a USB-C cable from the transmitter to the USB-A port.
 - Attaching a USB keyboard for entering text directly (e.g. receiver channel names) into the A20-Nexus Go.
 - Mounting a USB thumb drive for updating A20-Nexus Go firmware.
 - Jamming 8-Series timecode to an A20 transmitter via the A20-Nexus Go.

Attaching an A20-Nexus Go to an 8-Series

The A20-QuickDock accessory is required to mount the A20-Nexus Go to an 8-Series mixer-recorder. The following instructions apply to the A20-Nexus and A20-Nexus Go.

The A20-QuickDock comes with the following parts:

- Mounting plate with detachable Quick Release mechanism and multi-pin connector.
- 2 mm and 1/16" allen keys.
- Four 1/16" allen screws for securing the mounting plate to the bottom of the A20-Nexus Go.
- Three long 2 mm and two short 2 mm allen mounting pillars for securing the rear of the A20-Nexus Go with mounting plate to the top of the 8-Series.
- Additional mounting brackets and screws for Scorpio.

Use the following instructions for mounting and unmounting the A20-Nexus Go to an 8-Series mixer-recorder.

1. Ensure both A20-Nexus Go and 8-Series do not have power applied.
2. Place the A20-Nexus Go upside down on a clean, flat surface.

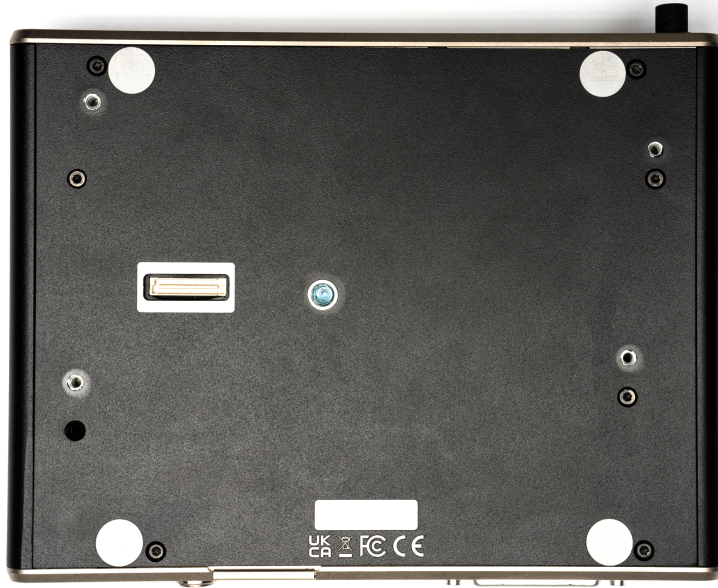

3. Position the QuickDock mounting plate on the bottom of the A20-Nexus Go

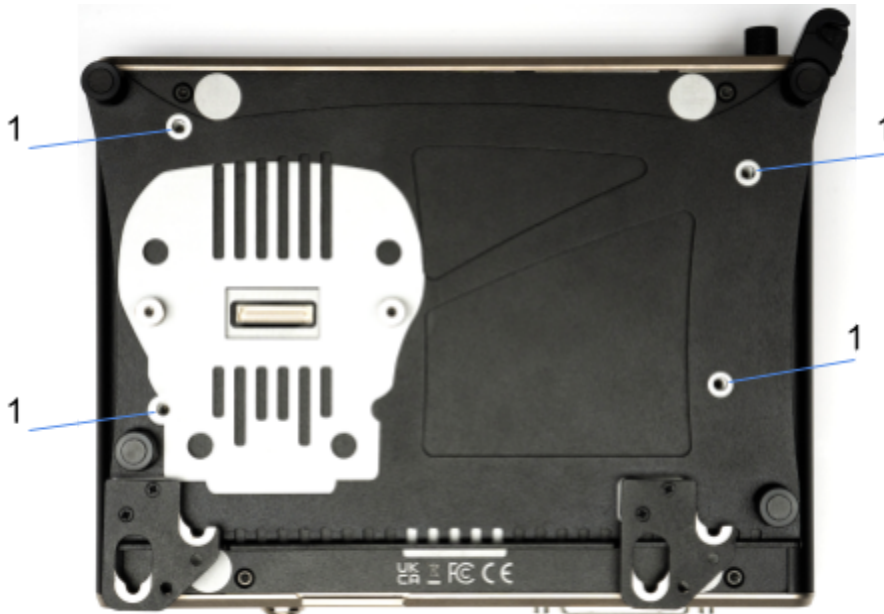

- a. Align the four mounting plate holes (1) with the screw holes on the bottom of the A20-Nexus Go.
4. Secure the mounting plate.
 - a. To make it easy to secure the mounting plate with the four allen screws, temporarily detach the Quick Release mechanism from the mounting plate (if not already done so) by squeezing together both the rear red levers and lifting.

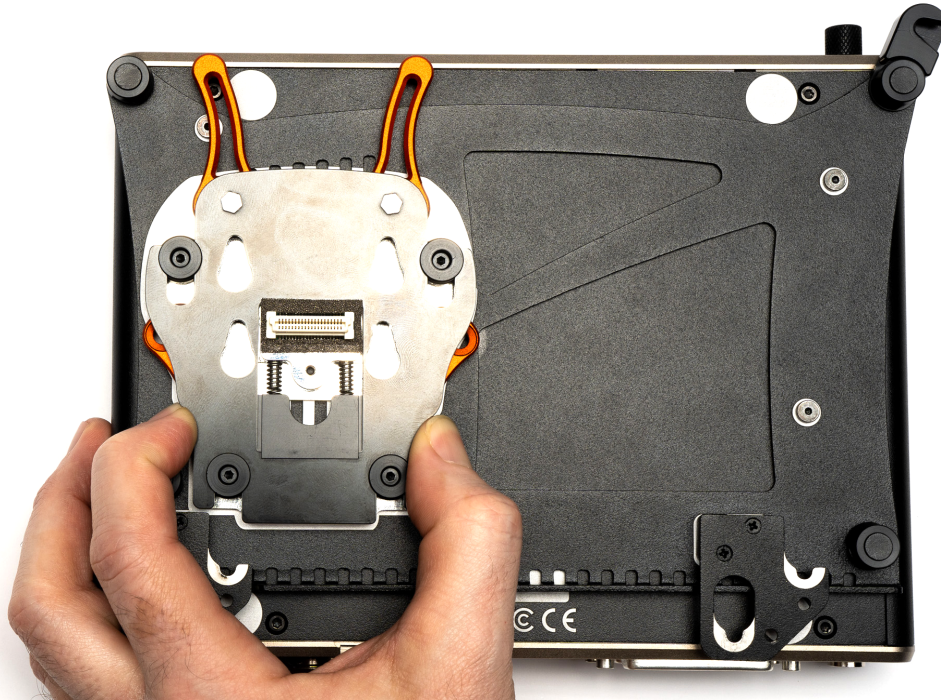

- b. Using the 1/16" allen key, secure the mounting plate by screwing the four allen screws into screw holes (1)
- c. Reattach the Quick Release mechanism. Squeeze both the rear red release levers and locate the quick-release mechanism so that the multi-pin connector mates with the expansion port on the A20-Nexus Go. Firmly press down and ensure the quick release mechanism is flush with the surface of the mounting plate.
- d. Scorpio only: Attach the two additional Scorpio mounting brackets using 2 screws per bracket as shown below.

Scorpio Only Brackets

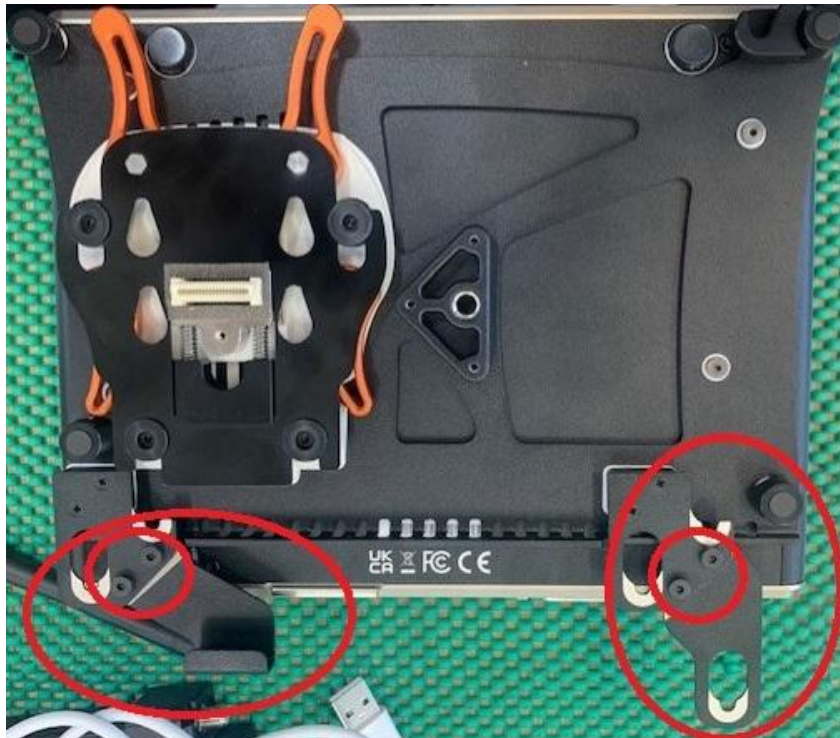

5. On the 8-Series, screw in the five mounting pillars.
 - a. Replace three screws (2) with the three long mounting pillars. **Note:** For Scorpio, only the top right corner screw (2) and bottom right pillar screw (2) need to be replaced with mounting pillars.
 - b. Screw in the two short mounting pillars into screw holes (3). **Note:** For Scorpio, use the two screw holes just below and either side of the bottom 16-pin expansion port.

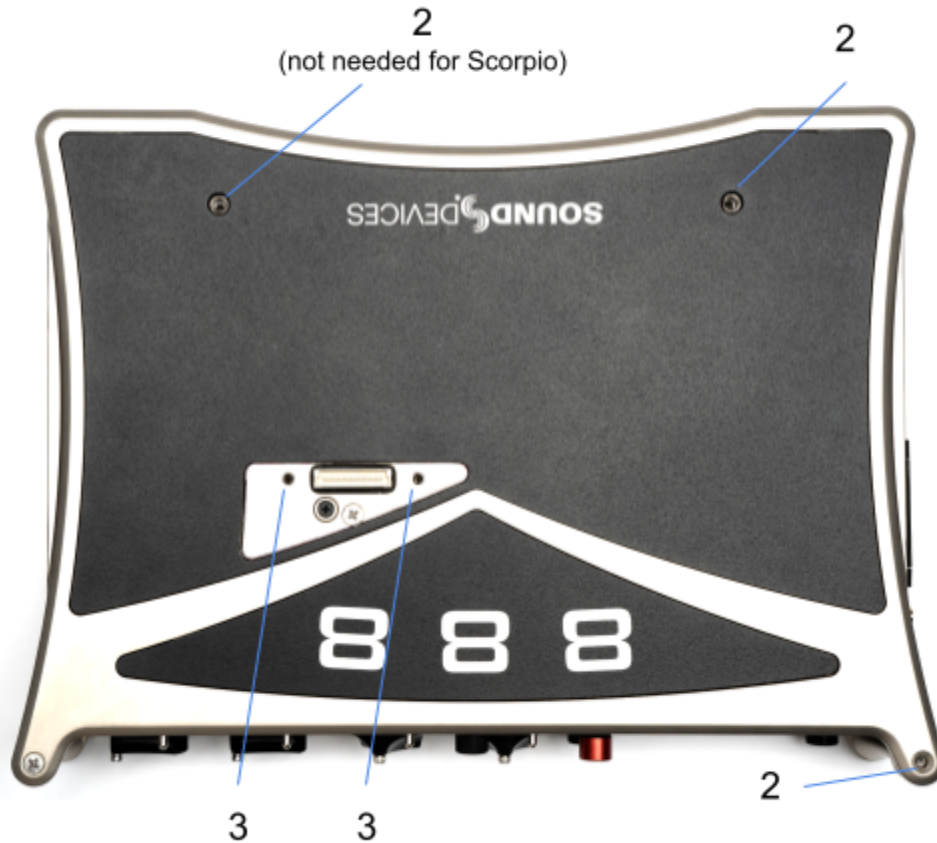

6. To mount the A20-Nexus Go with attached A20-QuickDock to the top of the 8-Series:
 - a. Start by hooking the Nexus mounting plate onto the two rear mounting pillars (833 and 888) or one rear mounting pillar (Scorpio).

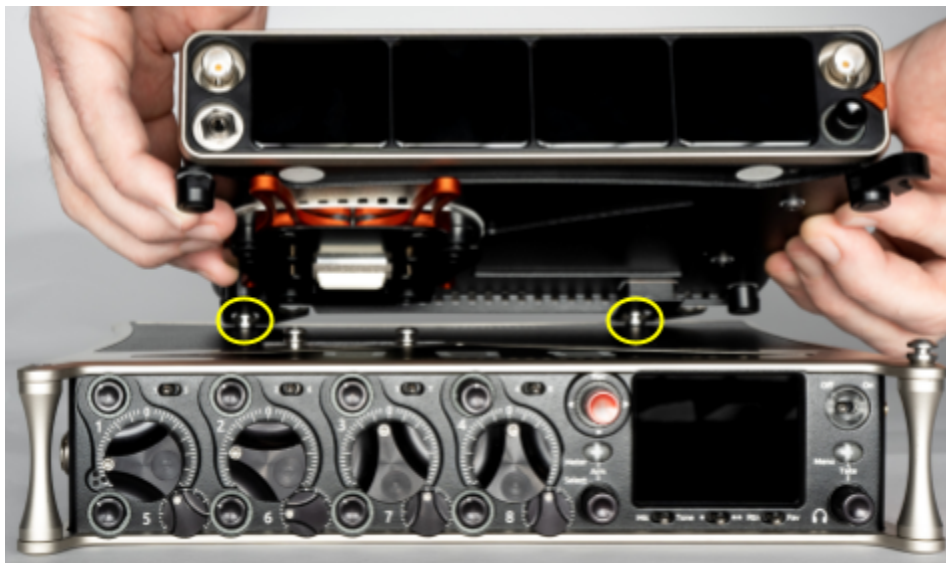

- b. Next, squeeze both front red release levers together and press down firmly on top of the A20-Nexus Go. Once located in place, release the red levers.



- c. Finally, slide the A20-Nexus Go's front-right black latch over the front-right 8-series mounting pillar.



7. To undock the A20-Nexus Go from the 8-Series:
 - a. Slide the A20-Nexus Go's front-right black latch off the 8-Series mounting pillar.
 - b. Squeeze both the front red release levers and lift the A20-Nexus Go from the front.
 - c. Slide out the A20-Nexus Go towards the rear of the 8-Series to unhook.

A20-Monarch Antenna

The A20-Nexus Go ships with two A20-Monarch, omnidirectional, wide-bandwidth (470-1525 MHz) antennas. These antennas provide uniform coverage and gain across the exceptionally wide SpectraBand tuning range of A20-Nexus Go. Each antenna is paired with a multi-function clamp and articulating arm, as well as an RG58 BNC-M to BNC-M cable (30 in.)



When purchased as a separate accessory, the A20-Monarch antenna also includes an RG174 BNC-M to SMA-M cable (18 in.)

The A20-Monarch kit comes with the following parts:

- 1x A20-Monarch antenna with BNC-F connector and 1/4"-20 female threaded mount
- 1x adjustable clamp and articulating arm with 1/4"-20 male threaded mount
- 1x 30 in/75 cm BNC-M to BNC-M cable
- 1x 18 in/45 cm BNC-M to SMA-M cable

A20-Shelf

The A20-Shelf is a 1RU, 19" rack shelf designed to accommodate two A20-Nexus Go or one A20-Nexus Go and one PowerStation-8M side by side. The shelf's rack ears have multiple fixing holes allowing the depth of the shelf to be adjusted. An A20-Nexus Go or PowerStation-8M can be mounted to the left, center, or right of the shelf. The A20-Shelf kit comes with the following parts:

- 1x rack shelf
- 2x rack ears
- 6x rack ear screws
- 8x mounting screws for securing in place two A20-Nexus Go or PowerStation-8M units, or one of each

Assembling the A20-Shelf

1. **Fitting the rack ears.** Each rack ear has multiple holes to allow the depth of the shelf to be adjusted. Position the rack ear on the side of the shelf, then select which three holes to use for the preferred depth, making sure to align them with the screw holes in the shelf's side panels. Fix in place using three rack ear screws.
2. **Mounting an A20-Nexus Go to the shelf.** Turn the shelf upside down then align the A20-Nexus Go front panel with the front edge of the shelf. The holes in the shelf tray allow the A20-Nexus Go to be positioned to the left, center, or right of the shelf.

A20-2.4G Ant+Mount

These easy-to-install adjustable antenna brackets are perfect for when the A20-Nexus Go is used in a bag and allow the 2.4 GHz antenna to be mounted on either side panel towards the front of the A20-Nexus Go, extending the 2.4GHz antenna out of the top of the bag for better NexLink range.

The A20-2.4G Ant+Mount Kit comes with the following parts:

- 1x 2.4 GHz Antenna (SMA-M)
- 1x 18 in/45 cm SMA-M to SMA-M Cable (RG58)

- 1x adjustable bracket with SMA-F coupler and mounting hardware
- 1x 1.5 mm allen key
- 1x 2.0 mm allen key
- 1x 3/32" allen key

Mounting the Antenna Brackets

1. **Remove the bracket screw hole protective covers:** Using the 1.5 mm allen key to unscrew the two protective covers from each Nexus side panel. Put the protective covers in a safe place should you need to reinstall them at a future time.

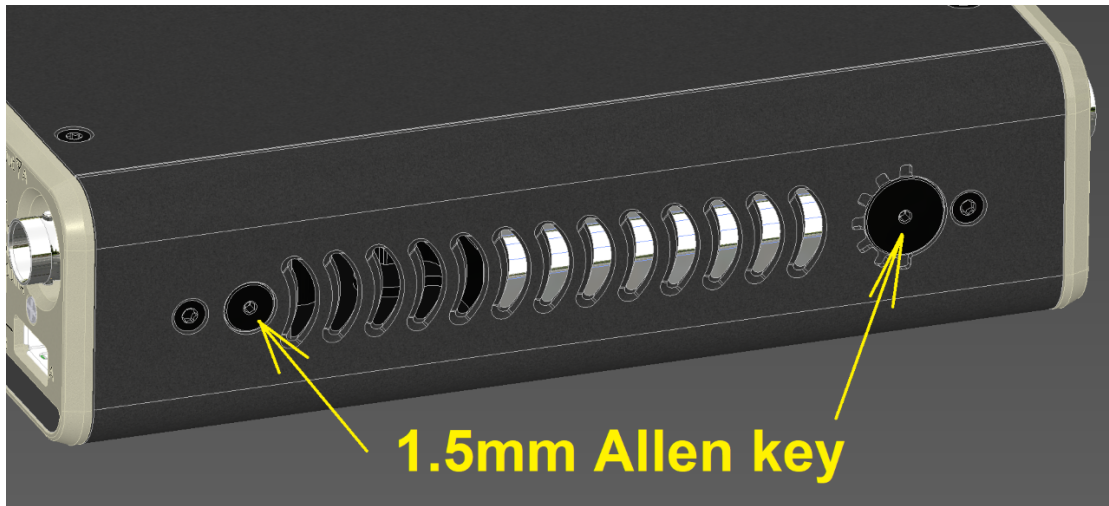

2. **Installing the adjustable antenna brackets:**
 - a. Position the adjustable bracket assembly (with fitted SMA to SMA cable) on the Nexus side panel so the 1/4" screw aligns with the screw hole near the front of the Nexus.
 - b. Use the 3/32" mm allen key to screw in the 1/4" bracket screw so that it loosely holds the bracket in place.
 - c. Adjust the lateral position and angle of the bracket to your preference, then tighten the bracket screw.
 - d. Adjust the position of the cable clamp so that it aligns with the side panel screw hole near the rear of the Nexus.
 - e. Use the 2 mm allen key to tighten the cable clamp.
 - f. Connect the SMA cable to the nearest rear panel 2.4 GHz SMA port.
 - g. Repeat above procedure for the other side's antenna bracket.



NexLink Status Alerts

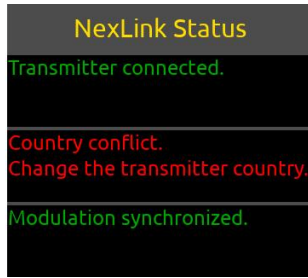

The NexLink Status View allows you to monitor NexLink communication between the A20-Nexus Go and A20 transmitters. This can assist in resolving NexLink issues. Access the NexLink Status View from the 1RX View Gear menu, TX View Gear menu, or, if the channel is sourced from multiple transmitters, directly from the 1RX View's NexLink Status button.

A receiver channel's Gear icon, NexLink Status button, and RF Frequency display turn red when there is a NexLink error.

NexLink Status Alerts

Message	Text Color	Description
Searching for transmitter	Yellow	An A20 transmitter has been linked to the Nexus but NexLink communication to the transmitter has not yet been established or has been lost. The transmitter may be out of range, or its battery drained.
Transmitter powered off	White	An A20 transmitter is NexLinked to Nexus and is powered off.
NexLink connected	Green	An A20 transmitter has been successfully NexLinked to Nexus
UHF frequency synchronized	Green	The frequency of the transmitter matches that of the receive channel that it is assigned to.
Modulation synchronized	Green	The modulation of the transmitter matches that of the receive channel that it is assigned to.
Frequency mismatch. Set the transmitter frequency.	Red	The frequency of an assigned transmitter does not match that of the receive channel. Manually set the transmitter frequency to the same frequency as the receiver channel or set the A20-Nexus Go's NexLink Tuning Mode to 'Push'.
Modulation mismatch. Set the transmitter modulation.	Red	The modulation setting of an assigned transmitter does not match that of the receive channel. Manually set the transmitter's modulation to the same modulation as the receiver channel or set the A20-Nexus Go's NexLink Tuning Mode to 'Push'.
Privacy key mismatch. Set the transmitter privacy key.	Red	The privacy key setting of an assigned transmitter does not match that of the receive channel. Manually set the transmitter's privacy key to the same modulation as the receiver channel or set the A20-Nexus Go's NexLink Tuning Mode to 'Push'.
Country conflict. Change the transmitter country.	Red	The country code of the transmitter does not match that of the Nexus. No synchronization of settings will be done until these match. Either change the country from A20-Remote or from the A20-Nexus Go.
No receive frequency. Set the receive frequency	White	The frequency of the receive channel is set to 'Off'. In the 1RX or 4RX View frequency popup, set the channel to a valid frequency and ensure the channel is 'On'.

Frequency Band Restrictions

The wireless system operator needs to be aware of local regulations and comply with all applicable laws regarding operation of wireless devices.

In some restricted frequency bands, the operator will need to obtain an unlock code from Sound Devices to assign a restricted frequency to the transmitter. Once a license has been granted, please contact Sound Devices (RF_Request@SoundDevices.com) to obtain the necessary unlock code.

An example of a frequency band requiring an unlock code in the United States is 1435-1525 MHz. Program Making and Special Events (PMSE) wireless operators typically call 1435-1525 MHz the "AFTRCC band". AFTRCC stands for Aerospace and Flight Test Radio Coordinating Council. This organization coordinates a number of frequency bands for use by air and spacecraft in the United States. This includes 1435-1525 MHz.

Per the United States Federal Communications Commission (FCC) rules, wireless microphones are allowed as secondary users in the 1435-1525 MHz AFTRCC band. This is detailed in the FCC Part 74 rules:

<https://www.ecfr.gov/current/title-47/chapter-I/subchapter-C/part-74>

One section of the Part 74 rules that's of particular interest to operators seeking an AFTRCC band license is 74.803(d):

[https://www.ecfr.gov/current/title-47/chapter-I/subchapter-C/part-74#p-74.803\(d\)](https://www.ecfr.gov/current/title-47/chapter-I/subchapter-C/part-74#p-74.803(d))

Similar to the 914.5 - 944 MHz band, nationwide licenses are not typically granted for wireless operation in 1435-1525 MHz.





Generally speaking, a wireless operator needs to show they've used all other available spectrum before the AFTRCC will consider a license request in the 1435-1525 MHz range. If granted, the license is normally assigned for a specific location and a specific time range.

Sound Devices encourages all wireless operators to obtain a Part 74 license, and specifically to make sure applicable parts of the 600 MHz and 950 MHz range are included with their license application. This can help show an operator is aware of the available spectrum and is utilizing it responsibly.

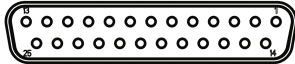
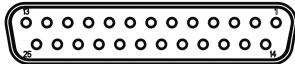
More information on Part 74 licensing can be found here: <https://www.local695.com/fcc-licensing/>

Connector Pin Assignments

Connector	Pin Assignments	Notes
<p>DB-25 (D-Sub) (Ch 1-8 Analog Out)</p> <p>8 analog output channels when two 2-ch expansion licenses are installed</p>		<p>1–Output 8 signal (+) 2–Output 8 Ground 3–Output 7 signal (-) 4–Output 6 signal (+) 5–Output 6 Ground 6–Output 5 signal (-) 7–Output 4 signal (+) 8–Output 4 Ground 9–Output 3 signal (-) 10–Output 2 signal (+) 11–Output 2 Ground 12–Output 1 signal (-) 13–unused 14–Output 8 signal (-) 15–Output 7 signal (+) 16–Output 7 Ground 17–Output 6 signal (-) 18–Output 5 signal (+) 19–Output 5 Ground 20–Output 4 signal (-) 21–Output 3 signal (+) 22–Output 3 Ground 23–Output 2 signal (-) 24–Output 1 signal (+) 25–Output 1 Ground</p> <p>Mates with DB-25 Male Connectors Wired per the AES59 standard</p>
<p>DB-25 (D-Sub) (Ch 1-8 AES Out)</p> <p>4 digital output signals (8 AES output channels) when two 2-ch expansion licenses are installed.</p>		<p>1–Digital Out 4 signal (+) 2–Digital Out 4 Ground 3–Digital Out 3 signal (-) 4–Digital Out 2 signal (+) 5–Digital Out 2 Ground 6–Digital Out 1 signal (-) 7–Unused 8–Unused 9–Unused 10–Unused 11–Unused 12–Unused 13–Unused 14–Digital Out 4 signal (-) 15–Digital Out 3 signal (+) 16–Digital Out 3 Ground 17–Digital Out 2 signal (-) 18–Digital Out 1 signal (+) 19–Digital Out 1 Ground 20–Unused 21–Unused 22–Unused 23–Unused 24–Unused 25–Unused</p> <p>Mates with DB-25 Male Connectors Wired per the AES59 standard.</p> <p>Digital Out 1 = Ch 1,2 Digital Out 2 = Ch 3,4 Digital Out 3 = Ch 5,6 Digital Out 4 = Ch 7,8</p>

BNC (LTC/WCK) input		Center pin - signal Sleeve - ground	75 ohm connector recommended
BNC (Front/Rear Antenna)		Center pin - signal Sleeve - ground	50 ohm connector recommended
SMA (2.4 GHz, Rear NexLink)		Center pin - signal Sleeve - ground	50 ohm connector recommended
TA4 (DC In)		Pin 1 = ground Pin 2 = Pin 3 = Pin 4 = positive volts	10-18V
4-pin Hirose (DC Out 1 & 2)		Pin 1 = ground Pin 4 = positive volts	10-18V, 500 mA max between both outputs (ie, 250 mA + 250 mA)
USB-A		Per USB-IF standard	5V, 500mA

A20-Nexus Go Specifications

Specifications are subject to change without prior notice. For the latest information available on all Sound Devices products, visit our website: www.sounddevices.com

Patents: The A20-Nexus Go is protected by US patents US10678294B2, US20190166523A1, International patent WO2018022209A1, and several patents pending.

RF

Tuning

- 169 to 1525 MHz (1356 MHz switching bandwidth)
- 25 kHz steps
- SpectraBand Technology for maximum rejection of out-of-band signals
- Available frequencies depend on country of operation

Modulation

- Proprietary, 100% digital RF modulation
- Standard or Long Range, selectable per channel

Spurious Rejection

- >100 dB typical

Cascade output

- 50 ohm
- 3.5 dB Insertion Loss from front BNC through rear BNC: It is recommended to use an external powered antenna to overcome the 3 dB splitting loss in the Nexus so that the receivers maintain excellent range.
- Wideband power split, pre-LNA

RF Bias output

- 12V, 200 mA each BNC
- Smart antenna support, Wisycom-compatible

Audio

Latency

- Standard modulation = 2 ms, analog or digital outputs
- Long Range modulation = 3.9 ms, analog or digital outputs

Audio Frequency Response

- 10 Hz–20 kHz, +/- 1 dB relative to 1 kHz

Dynamic Range

- > 130 dB with an A20 transmitter

Output Level

- Line-level: +20 dBu for 0 dBFS
- Mic-level: -20 dBu for 0 dBFS

Audio Output Sample Rate

- 44.1, 48, or 96 kHz

Digital Audio Output

- AES3 balanced connection, 110 ohm output impedance

Powering

Sources

- TA4 DC Input
- 8-Series (through unit-to-unit connector when docked)

- AC mains adapter (sold separately)

Levels

- DC input, 10 to 18V in, 2A minimum at 10 VDC
- 10W idle, default configuration
- Extra power passed through for USB power, active antenna power, and DC output power
- USB-A: 5V, 500 mA output; supports keyboards, thumb drives, A20 transmitters, and USB hubs
- DC Outs: max 500 mA between both outputs.

Environmental**Operating Temperature Range**

- -10 °C to +55 °C

Dimensions (H x W x D)

- 4.0 cm x 20.3 cm x 16.7 cm
- (1.6 in x 8.0 in x 6.6 in)

Weight

- 1.22 kg (unpackaged)
- 2.7 lbs (unpackaged)

A20-Monarch Specifications

Frequency range

- 470 MHz - 1600 MHz

Gain

- 2.2 dBi

Pattern

- Omnidirectional

Return Loss

- Better than 15 dB across entire 470 - 1600 MHz range

Mounting Threads

- ¼"-20

Dimensions (H x W x D)

- 17.0 cm x 21.0 cm x 1.7 cm
- (6.68 in x 8.26 in x 0.67 in)

Weight

- 0.12 kg (unpackaged)
- 0.26 lbs (unpackaged)

Note on RF Interference

Sound Devices does not guarantee the absence of any interfering spurs across all bands in all situations. Some small spurs can originate within the Nexus, and others can come from many sources (AES/EBU interconnects, external mixer-recorders, USB drives, USB keyboards, etc.). This, combined with the extreme sensitivity of the A20-Nexus Go's front end, mean that the user has to be very careful with the quality of cables used, as well as antenna and antenna cable routing and placement.

We highly recommend placing antennas as far as possible from other pieces of equipment, especially antennas from intentional transmitters, such as IFB units.

Servicing the A20-Nexus Go

Do not attempt to service the A20-Nexus Go. The internal parts are microscopic and not user serviceable. Please send to Sound Devices for any service needs. <https://service.sounddevices.com/contact-support/>

Warranty

Sound Devices, LLC warrants the items listed above against defects in materials and workmanship for a period of ONE (1) year from date of original retail purchase. Users who register their product directly with Sound Devices Technical Support using the online form or by phone, will receive an additional ONE (1) year of warranty coverage, extending the complete warranty period to TWO (2) years from the date of original retail purchase. In order to extend the warranty coverage period, registration must be completed within the initial ONE (1) year warranty period. Products must be purchased through authorized Sound Devices resellers to qualify for Warranty coverage. Damage resulting from the opening of a Sound Devices product or attempted repairs by a non-authorized Sound Devices repair technician will void warranty coverage.

This is a non-transferable warranty that extends only to the original purchaser. Sound Devices, LLC will repair or replace the product at its discretion at no charge. Warranty claims due to severe service conditions will be addressed on an individual basis.

THE WARRANTY AND REMEDIES SET FORTH ABOVE ARE EXCLUSIVE. SOUND DEVICES, LLC DISCLAIMS ALL OTHER WARRANTIES, EXPRESS OR IMPLIED, INCLUDING WARRANTIES OF MERCHANTABILITY AND FITNESS FOR A PARTICULAR PURPOSE. SOUND DEVICES, LLC IS NOT RESPONSIBLE FOR SPECIAL, INCIDENTAL, OR CONSEQUENTIAL DAMAGES ARISING FROM ANY BREACH OF WARRANTY OR UNDER ANY OTHER LEGAL THEORY. Because some jurisdictions do not permit the exclusion or limitations set forth above, they may not apply in all cases.

For all service, including warranty repair, please contact Sound Devices for an RMA (return merchandise authorization) before sending your unit in for repair. Products returned without an RMA number may experience delays in repair. When sending a unit for repair, please do not include accessories, including SSD drives, CF cards, batteries, power supplies, carry cases, cables, or adapters unless instructed by Sound Devices. Sound Devices repairs and replacements may be completed using refurbished, returned or used parts that have been factory certified as functionally equivalent to new parts.

Sound Devices, LLC

Services Repair RMA #XXXXXX

E7556 State Road 23 and 33
Reedsburg, WI 53959 USA
Telephone: +1-608-524-0625

Legal Notices

Product specifications and features are subject to change without prior notification. Read and fully understand this manual before operation.

Copyright© 2023 Sound Devices, LLC. All rights reserved. This product is subject to the terms and conditions of a software license agreement provided with the product, and may be used in accordance with the license agreement. This document is protected under copyright law. An authorized licensee of this product may reproduce this publication for the licensee's own personal use. This document may not be reproduced or distributed, in whole or in part, for commercial purposes, such as selling copies or providing educational services or support. This document is supplied as a technical guide. Special care has been taken in preparing the information for publication; however, since product specifications are subject to change, this document might contain omissions and technical or typographical inaccuracies. Sound Devices, LLC does not accept responsibility for any losses due to the use of this guide.

LIMITATION ON SOUND DEVICES' LIABILITY. TO THE FULLEST EXTENT PERMITTED BY LAW, SOUND DEVICES SHALL HAVE NO LIABILITY TO THE END USER OR ANY OTHER PERSON FOR COSTS, EXPENSES, DIRECT DAMAGES, INCIDENTAL DAMAGES, PUNITIVE DAMAGES, SPECIAL DAMAGES, CONSEQUENTIAL DAMAGES OR OTHER DAMAGES OF ANY KIND OR NATURE WHATSOEVER ARISING OUT OF OR RELATING TO THE PRODUCTS, THESE TERMS AND CONDITIONS OR THE PARTIES' RELATIONSHIP, INCLUDING, WITHOUT LIMITATION, DAMAGES RESULTING FROM OR RELATED TO THE DELETION OR OTHER LOSS OF AUDIO RECORDINGS OR DATA, REDUCED OR DIMINISHED AUDIO QUALITY OR OTHER SIMILAR AUDIO DEFECTS ARISING FROM, RELATED TO OR OTHERWISE ATTRIBUTABLE TO THE PRODUCTS OR THE END USER'S USE OR OPERATION THEREOF, REGARDLESS OF WHETHER SUCH DAMAGES ARE CLAIMED UNDER CONTRACT, TORT OR ANY OTHER THEORY. "CONSEQUENTIAL DAMAGES" FOR WHICH SOUND DEVICES SHALL NOT BE LIABLE SHALL INCLUDE, WITHOUT LIMITATION, LOST PROFITS, PENALTIES, DELAY DAMAGES, LIQUIDATED DAMAGES AND OTHER DAMAGES AND LIABILITIES WHICH END USER SHALL BE OBLIGATED TO PAY OR WHICH END USER OR ANY OTHER PARTY MAY INCUR RELATED TO OR ARISING OUT OF ITS CONTRACTS WITH ITS CUSTOMERS OR OTHER THIRD PARTIES. NOTWITHSTANDING AND WITHOUT LIMITING THE FOREGOING, IN NO EVENT SHALL SOUND DEVICES BE LIABLE FOR ANY AMOUNT OF DAMAGES IN EXCESS OF AMOUNTS PAID BY THE END USER FOR THE PRODUCTS AS TO WHICH ANY LIABILITY HAS BEEN DETERMINED TO EXIST. SOUND DEVICES AND END USER EXPRESSLY AGREE THAT THE PRICE FOR THE PRODUCTS WAS DETERMINED IN CONSIDERATION OF THE LIMITATION ON LIABILITY AND DAMAGES SET FORTH HEREIN AND SUCH LIMITATION HAS BEEN SPECIFICALLY BARGAINED FOR AND CONSTITUTES AN AGREED ALLOCATION OF RISK WHICH SHALL SURVIVE THE DETERMINATION OF ANY COURT OF COMPETENT JURISDICTION THAT ANY REMEDY HEREIN FAILS OF ITS ESSENTIAL PURPOSE.

The "wave" logo is a registered trademark of Sound Devices, LLC. Windows is a registered trademark of Microsoft Corporation in the U.S. and other countries. Bluetooth LE is a registered trademark of Bluetooth SIG, Inc. Android is a registered trademark of Google. iPad, iPhone, and iOS are registered trademarks of Apple Inc. All other trademarks herein are the property of their respective owners.

FCC Conformity



NOTE: This equipment has been tested and found to comply with the limits for a Class B digital device, pursuant to part 15 of the FCC Rules. These limits are designed to provide reasonable protection against harmful interference in a residential installation. This equipment generates, uses and can radiate radio frequency energy and, if not installed and used in accordance with the instructions, may cause harmful interference to radio communications. However, there is no guarantee that interference will not occur in a particular installation. If this equipment does cause harmful interference to radio or television reception, which can be determined by turning the equipment off and on, the user is encouraged to try to correct the interference by one or more of the following measures:

- Reorient or relocate the receiving antenna.
- Increase the separation between the equipment and receiver.
- Connect the equipment into an outlet on a circuit different from that to which the receiver is connected.
- Consult the dealer or an experienced radio/TV technician for help.

This device complies with FCC RF exposure limits for general population / uncontrolled environments. A separation distance of at least 20 cm must be maintained between the antenna and all persons. This device must not be co-located with any other antenna or transmitter. This device has been approved to operate with the antenna type listed below:

Model: W1010	Type: Wireless External Antenna for 2.4 GHz Application
Manufacturer: PulseLarson	Max. Gain: 2.0dBi

No change to the antenna type is permitted. Any change to the antenna could result in the device exceeding the RF exposure requirements and void the user's authority to operate the device.

Changes or modifications not expressly approved by the manufacturer could void the user's authority to operate the equipment.

To comply with FCC part 15 rules in the United States, the A20-Nexus Go receiver must be professionally installed. It is the responsibility of the operator and professional installer to ensure that only certified antennas are to be used in the United States.

Industry Canada Conformity

This device complies with ISED RF exposure limits for general population / uncontrolled environments. A separation distance of at least 20 cm must be maintained between the antenna and all persons. This device must not be co-located with any other antenna or transmitter. This device has been approved to operate with the antenna type listed below:

Model: W1010

Manufacturer: PulseLarson

Type: Wireless External Antenna for 2.4 GHz Application

Max. Gain: 2.0dBi

No change to the antenna type is permitted. Any change to the antenna could result in the device exceeding the RF exposure requirements and void the user's authority to operate the device.

This Device complies with Industry Canada License-exempt RSS standard(s). Operation is subject to the following two conditions: 1) this device may not cause interference, and 2) this device must accept any interference, including interference that may cause undesired operation of the device.

Cet appareil se conforme aux normes ISED sur les limites d'exposition aux radiofréquences pour la population générale et environnements non contrôlés. Une distance minimale d'au moins 20cm doit être maintenue entre l'antenne et toute personne. Cet appareil ne doit pas être co-localisé avec toute autre antenne ou transmetteur. Cet appareil a été approuvé pour fonctionner avec le type d'antenne ci-dessous:

Model: W1010

Manufacturer: PulseLarson

Type: Antenne externe sans fil pour application à 2.4 GHz

Gain Max: 2.0 dBi

Aucun changement de type d'antenne n'est permis. Tout changement sur l'antenne pourrait causer l'appareil à excéder les limites d'exposition RF et annuler le droit de l'utilisateur à faire fonctionner cet appareil.

Cet appareil est conforme avec Industrie Canada, exempts de licence standard RSS (s). Son fonctionnement est soumis aux deux conditions suivantes: 1) ce dispositif ne peut pas causer d'interférences, et 2) ce dispositif doit accepter toute interférence, y compris les interférences qui peuvent causer un mauvais fonctionnement de l'appareil.

WEEE Statement

If you wish to discard a Sound Devices product in Europe, contact Sound Devices (England) for further information.



Declaration of Conformity



Manufacturer's Name: Sound Devices, LLC
Manufacturer's Address: E7556 State Road 23 and 33 Reedsburg, WI 53959 USA

We, Sound Devices LLC, declare under our sole responsibility that the product

Product Name: A20-Nexus Go
Model Number: A20-Nexus Go
Description: Digital Wireless Receiver

is in conformity with the essential requirements of the following relevant Union harmonisation legislation:

Radio Equipment Directive (RED) 2014/53/EU
Low Voltage Directive 2014/35/EU
RoHS Directive 2011/65/EU

The following harmonised standards and/or normative documents were applied:

Health & Safety (Article 3.1(a) of RED) EN 62368-1:2014
EN 50566:2017

EMC (Article 3.1(b) of RED) EN 301-489-1 v2.2.3:2019
EN 301-489-9 v2.1.1:2019
EN 301-489-17 v3.2.4:2020

RF Spectrum (Article 3.2 of RED) EN 300 422-1 v2.1.2:2017
EN 300 328 v2.2.2:2019
EN 300 440 v2.1.1:2017

Signed for and on behalf of Sound Devices LLC:

July 21st, 2023

Date

Matt Anderson - Sound Devices, LLC President

SOUND  **DEVICES**

Post Office Box 576
E7556 State Rd. 23 and 33
Reedsburg, Wisconsin 53959 USA

support@sounddevices.com

+1608.524.0625 main
800.505.0625 toll free (U.S. only)

www.sounddevices.com